



BSC BSC-BAC BSC-8X

Modulating Control

Modulating BACnet Control

Modulating Extension

MODULATING BOILER CONTROL WITH BACNET COMMUNICATION OPTION

INSTALLATION AND OPERATION INSTRUCTIONS MANUAL

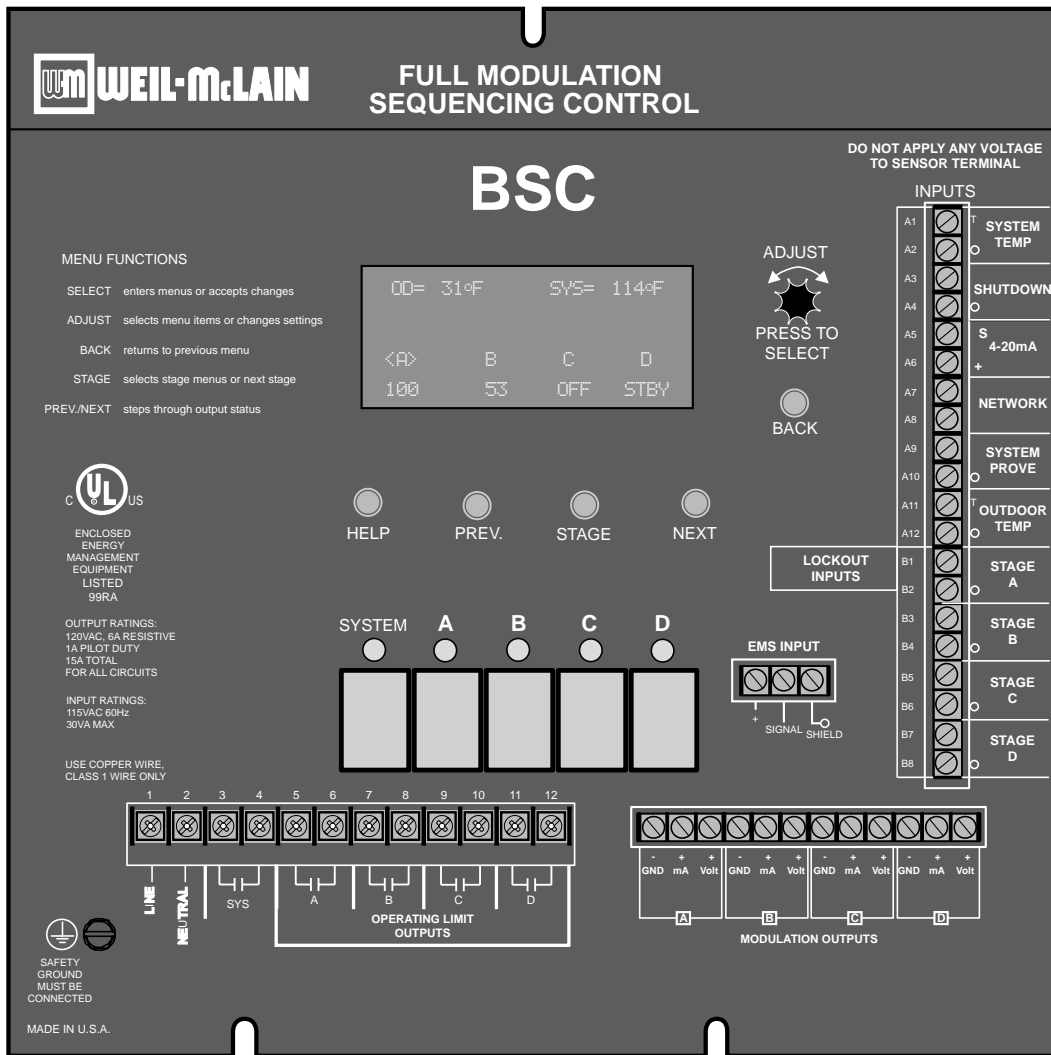

WARNING

This Weil McLain control is strictly an operating control; it should never be used as a primary limit or safety control. All equipment must have its own certified limit and safety controls required by local codes. The installer must verify proper operation and correct any safety problems prior to the installation of this Weil McLain control.

Content

BSC FUNCTION CHART	3	Reset Ratio	18
BSC OVERVIEW	4	Offset	18
Reset Ratio/Outdoor Reset5	Minimum Water Temperature	18
INSTALLATION	6	Gain/Throttle	19
Mounting the Enclosure6	Lead Stage	19
Wiring the Power6	Lead Auto Rotate	19
Input Wiring	6	Purge Delay	20
Wiring the Outdoor sensor6	Lag Delay	20
Wiring The System Sensor7	Standby Time	20
Wiring an External Set Point (4-20mA Input)7	System Run-On	21
Wiring the Shutdown7	Setback	21
Wiring the System Prove8	Rotate Time	21
Wiring the Lockout Inputs8	Last-Stage-Hold	21
Wiring A Setback8	Avoid Conflicting Boiler Limits	22
Output Wiring	9	Set Point and Default Table	22
Wiring the System Output9	SECURITY	23
Wiring the Stage Outputs9	Enable the Password	23
Modulating Output Card	10	Change the Password	23
BACnet Communication Wiring	10	Set the Time	23
Wiring The BSC to Extension Panels	11	STAGE SETTINGS	24
USING THE MENUS	12	The Stage Menu	24
Menu Basics	12	Moving around the Stages Menus	24
The Main Display	12	Mode	24
Display Stage Modulation Status	12	Ignition %	25
Display Messages	12	Modulation Start	25
SYSTEM STARTUP	13	Copy Settings (Stage A Only)	26
Startup Sequence	13	MAINTENANCE	27
Sensor Type	13	System and Outdoor Trim	27
EMS Input Mode	13	Stage Output Trim	27
4 & 20mA Set Points	16	Soft-off Delay	27
Output Type	16	Modulation Speed	27
Modulating Mode	16	BACNET COMMUNICATION	28
Operating Mode	16	BACnet Communication Option	28
Heat/Cool Mode	17	BACnet Device ID	28
Sensor Fault	17	IP Address	28
MENU SETTINGS	14	Mask Address	28
MENU SETTINGS CONTINUED.	15	Gateway Address	28
OPERATING SETTINGS	17	BSC BACnet Variable List	28
Set Point	17	TROUBLESHOOTING	30
Outdoor Cutoff Temperature	17	BSC SPECIFICATIONS	32

BSC FUNCTION CHART

Digital display shows the system status, setpoint, lead stage <in brackets>, and status of each stage. To view and adjust settings, press the Adjust/Select button.

Depress the knob to move forward through the menus and to accept changes. To change a setting's value, rotate the knob.

Depress the button to go back through the menus

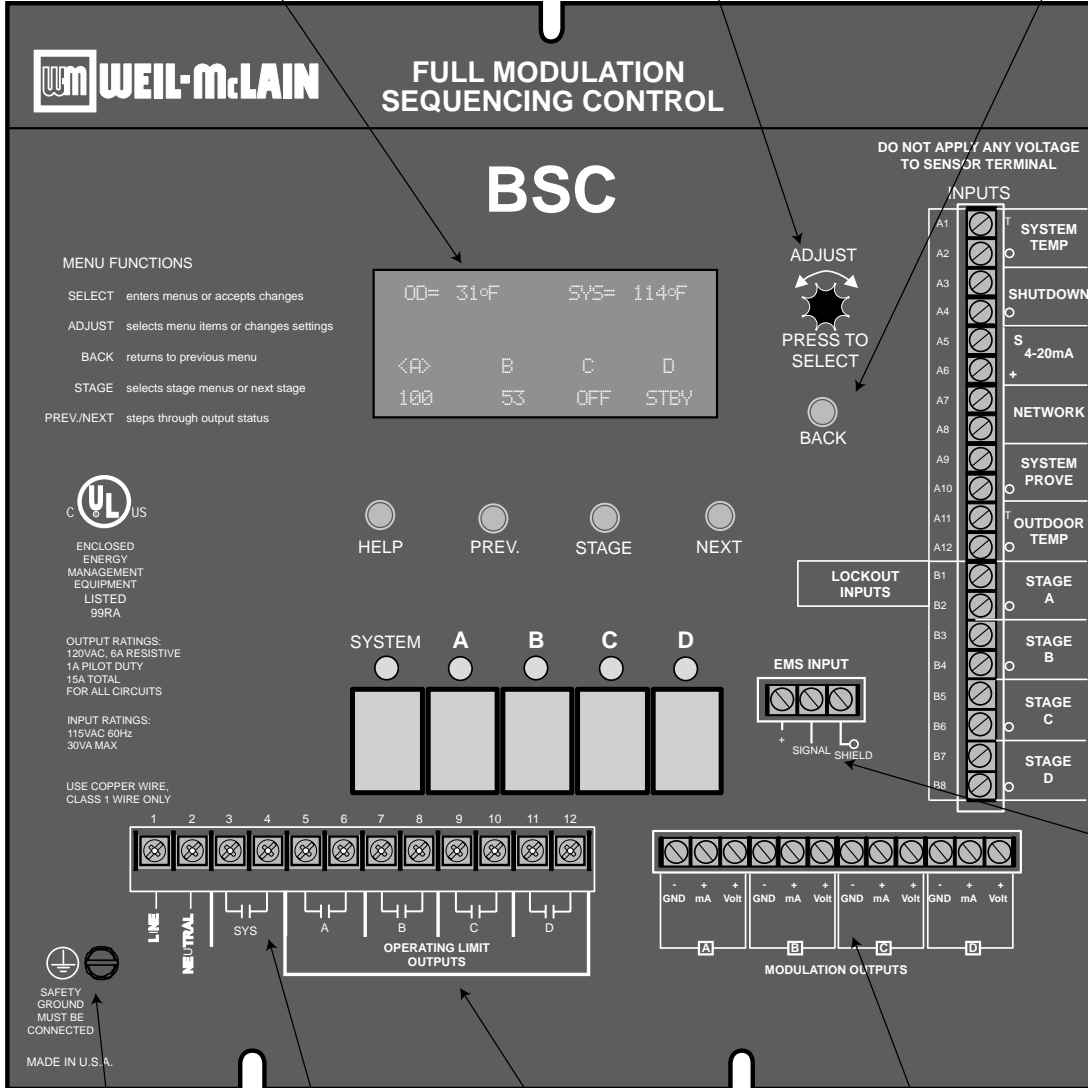

From heating system sensor

When closed, all stages are turned off*

Setback

Checks status of system components*

From outdoor sensor mounted in the shade

If a unit is in LockOut, the BSC will not consider it an active stage*

Connect to remote 4-20mA set point signal or to dry-contact setback signal

Green Ground screw must be connected to Earth Ground

System output controls pumps, valves or other system components.

Each N.O. output is wired in series with the each unit's limit circuit.

The modulation outputs can be 0-5V, 0-10V, 1-5V, 2-10V, 4-20mA, 0-135 Ohm. Different output boards mount on the back of the BSC to determine the type of output.

BSC OVERVIEW

Sequences up to 4 Fully Modulating Stages

The BSC is the perfect control whenever multiple fully modulating stages are required for heating or cooling applications. The BSC controls the modulation of each stage to maintain precise set point control.

PID Type Logic

The BSC's control algorithm allows it to look at the rate of change in the system. If the system temperature/pressure is changing quickly, the BSC will react quickly to adjust the stages' modulating output. If the system temperature/pressure changes slowly, the BSC will make slow and gradual adjustments. Therefore, the BSC adapts to specific system requirements and minimizes fluctuations around the set point.

Controls 0-5V, 0-10V, 1-5V, 2-10V, 4-20 mA, or 0-135Ω modulating motors

The BSC is designed to accurately control the output from 0 to 100% of modulation for each of these different types of motors. One BSC can even control two different types of motors.

Process or Normal Applications

The BSC controls the stages based on the type of logic selected. It offers a Normal (PID) logic for slow responding systems. This option is useful in heating applications where In addition, it offers a Process option for systems that requires fast response.

Digital Display of all System Settings

The BSC's 80 character alphanumeric digital display names each system parameter in plain English and shows its precise value. The easy to follow menu system allows users to quickly make changes to any system setting without having to learn any specialized codes or keyboard commands. Password protection is available to prevent unauthorized users from making adjustments to control settings.

Automatic Rotation among Stages

Rotating the first stage to be activated on a call for output promotes even wear on each stage. The BSC has three modes of rotation: Manual, *Last-On*, or Automatic every selected time period from every hour to every 41 days.

Outdoor Reset Control

The BSC has a stand-alone hydronic outdoor temperature reset function (When Sensor Type is set to Reset °F or Reset °C.). This allows it to change the target set point based on outdoor temperature changes.

Connects to Energy Management Systems

BSCs can accept a 4-20 mA input signal from an EMS to adjust the temperature set point remotely. In addition, an Energy Management System (EMS) or other controller can disable the BSC when there is no output requirement.

Monitors Stage Status

The BSC is designed to accept Lockout inputs from each stage. If any stage is in Lockout, the BSC will automatically skip it when adding more capacity. If a stage goes into Lockout during normal operation, the next stage will be activated immediately to maintain the desired output capacity.

System Output is Active when Any Stage is Active

This output can be used to activate a system pump, combustion air damper, or perform any other function that is required when any stage is active. A System Prove input checks the status of components activated by the System output before stages can be activated.

BACnet IP Remote Communication Upgrade Available

The BSC can be upgraded to include a BACnet IP remote communication package to monitor and control all BSC functions from a remote location.

UNDERSTANDING OPERATION CONCEPT

The BSC has multiple operating modes that satisfy most hydronic systems. It can change the System Set Point based on outdoor temperature (Outdoor Reset) or it can modulate its stages to achieve an adjustable fixed Set Point.

In Outdoor Reset, the BSC controls a hot water heating system to provide a building with comfortable and even heat levels. The BSC varies the temperature of the circulating heating water in response to changes in the outdoor temperature. The heating water temperature is controlled through the modulation of the stages.

The BSC also controls the system circulating pump with an adjustable Outdoor Cutoff. When the outdoor temperature is above Outdoor Cutoff, the pump is off and no heating water is circulated through the system. When the outdoor temperature drops below the Outdoor Cutoff, the system pump relay is activated and the heating water circulates through the system. The temperature of the heating water is controlled by the Reset Ratio, Water Offset, and the Outdoor temperature.

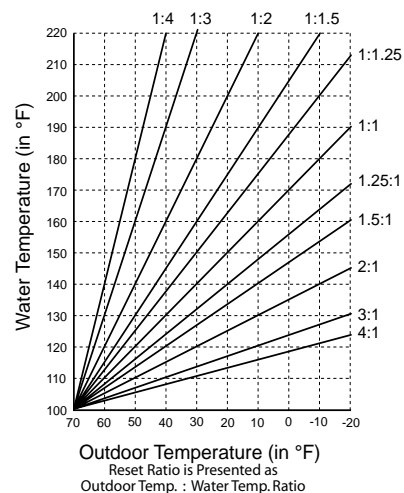

Reset Ratio Curves

RESET RATIO/OUTDOOR RESET

When a building is being heated, heat escapes through the walls, doors, and windows to the colder outside air. The colder the outside temperature, the more heat escapes. If you can input heat into the building at the same rate that it is lost out of the building, then the building temperature will remain constant. The Reset Ratio is an adjustment that lets you achieve this equilibrium between heat input and heat loss.

The starting point for most systems is the 1.00 (OD):1.00 (SYS) (Outdoor Temperature : Heating Water Temperature) ratio. This means that for every degree the outdoor temperature drops, the temperature of the heating water will increase one degree. The starting point of the curves is adjustable, but comes factory selected at 70°F Outdoor Temperature and 100°F Water Temperature. For example with a 1.00 (OD):1.00 (SYS) ratio, if the outdoor temperature is 50°F, this means the temperature has fallen 20° from the starting point of 70°F. Therefore, the heating water temperature will increase 20° to 120°F.

Each building has different heat loss characteristics. A very well insulated building will not lose much heat to the outside air, and may need a Reset Ratio of 2.00 (OD):1.00 (SYS) (Outdoor : Water). This means the outdoor temperature would have to drop 2 degrees to increase the water temperature 1 degree. On the other hand, a poorly insulated building with insufficient radiation may need a Reset Ratio of 1.00 (OD):2.00 (SYS). This means that for each degree the outdoor temperature drops the water temperature will increase 2 degrees. The BSC has a full range of Reset Ratios to match any buildings heat loss characteristics.

A heating curve that relies not only on Outdoor temperature but also on type of radiation will improve heat comfort. The following are suggested initial settings for different types of radiation based on average building insulation and heat loss. The contractor can fine tune these adjustments based on the specific building need.

Type of Radiation in Building	Reset Ratio	Offset
Radiators (Steel & Cast Iron)	1.00 (OD) : 1.00 (SYS)	0°F
Baseboard (Finned copper tube & Cast Iron)	1.00 (OD) : 1.00 (SYS)	0°F
Radiant (High Mass/Concrete)	4.00 (OD) : 1.00 (SYS)	-10°F
Radiant (Low Mass/Joists)	2.00 (OD) : 1.00 (SYS)	-10°F
Fan Coils & Air Handlers	1.00 (OD) : 1.00 (SYS)	20°F

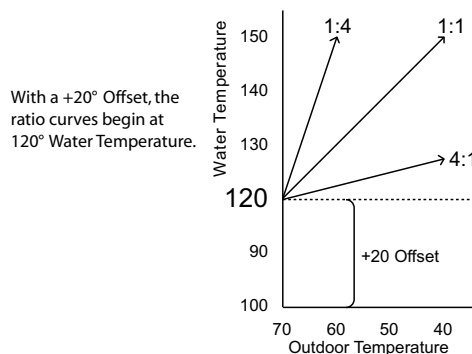
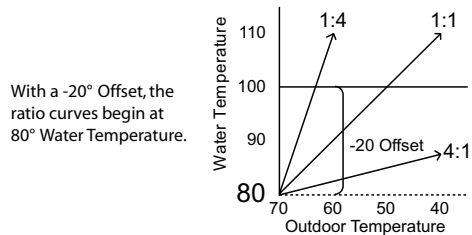
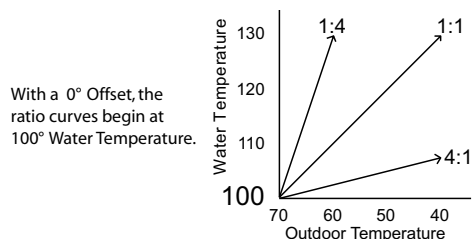

⚠ WARNING

When controlling a non condensing boiler directly without the use of a mixing valve, minimum boiler water temperature must be set to boiler manufacturer specifications. In that case, system temperature must not go below such temperature.

INSTALLATION

MOUNTING THE ENCLOSURE

- Select a location near the equipment to be controlled.
- The surface should be flat and sufficiently wide and strong to hold the BSC.
- Keep the BSC panel away from extreme heat, cold, or humidity. Its ambient operating temperature is from 20 to 120°F.
- Remove the panel from the metal enclosure by removing the top center screw and loosening the two bottom screws. Lift the panel out.
- Screw the enclosure to the surface through the mounting holes in the back of the enclosure.
- Return the panel to the enclosure. Replace the top screw and tighten the bottom two screws.

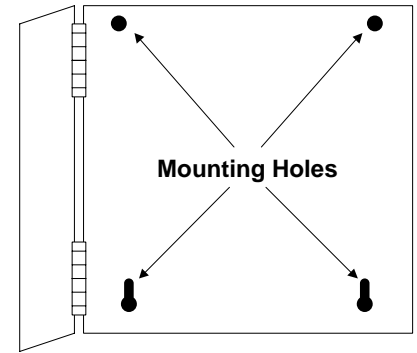

WIRING THE POWER

- Bring the 120VAC 60Hz power wires through a bottom knockout (KO) of the enclosure. The left bottom KO is preferred.
- Class 1 voltage wiring must enter the enclosure through a different knockout from any Class 2 voltage.
- Connect the hot line to terminal marked *LINE*.
- Connect the neutral line to the terminal marked *NEUTRAL*.
- The green ground screw **MUST** be connected to Earth Ground.
- Weil McLain recommends the installation of a Surge Suppressor and a Power Switch before the Power Line connection for safety and ease of service.

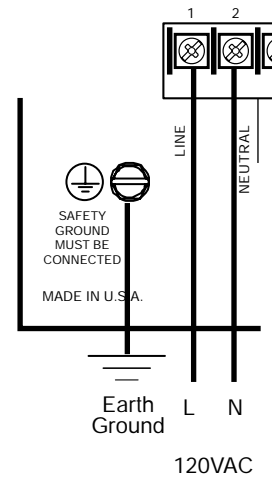

INPUT WIRING

WIRING THE OUTDOOR SENSOR

- To enable the reset function, an outdoor sensor must be used. See Sensor Type settings on page 13.
- The outdoor sensor can be used as an Outdoor Cutoff for temperature set point systems. The BSC will disable all stages when the outdoor temperature is above the adjustable Outdoor Cutoff temperature. See page 17. This feature will automatically be activated when an outdoor sensor is connected.

INSTALLING THE SENSOR

- Only use the Weil McLain Outdoor Sensor included with the unit (389-900-229).
- Locate the sensor in the shade on the north side of the building. The sensor should never be in direct sunlight.
- Be sure the location is away from doors, windows, exhaust fans, vents, or other possible heat sources.
- The sensor should be mounted approximately 10' feet above ground level.
- Adhere the Outdoor Label provided to the back of the sensor base.
- Use the Sensor Enclosure Base bottom knockout for the conduit. Use the locknut to hold the conduit and enclosure base together. Screw the cover to the base.
- If screws are used to affix the enclosure to the wall, make sure to seal around the sensor and wall except from the bottom.
- The sensor wires can be extended up to 500' using 2-conductor shielded cable (Belden #8760 or equivalent (#18/2)). Do not ground the shield at the sensor but at the control using the BSC Outdoor Sensor terminal marked with an "O" (A12).
- Do not run sensor wires in conduit with line voltage wiring.

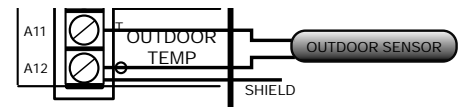

Outdoor Sensor

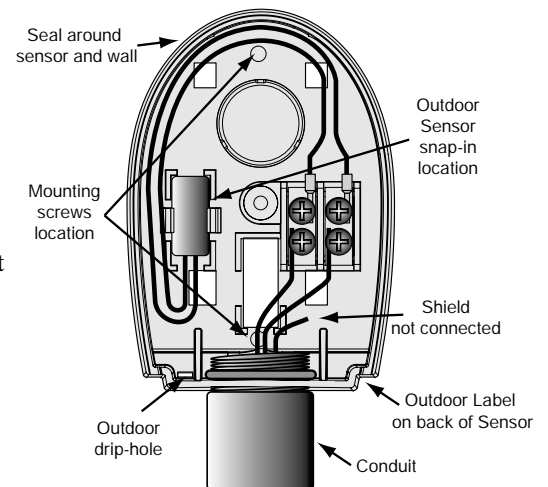

▲ ALERT

Determining the proper location for the Outdoor Sensor is very important. The BSC will base the heat on the outdoor temperature information it receives from this location. If the sensor is in the sun, or covered with ice, its reading will be different from the actual Outdoor temperature (OD).

WIRING THE SYSTEM SENSOR

For proper operation, the BSC must be connected to a temperature or pressure sensor located in the common header.

SYSTEM TEMPERATURE

- The BSC is designed to be connected to a Weil McLain temperature sensor 389-900-230 for insertion in a 3/8ID well (592-300-023).
- Locate the sensor in the common header where it will register the output of all the stages before any takeoffs. If the sensor cannot read the output of all the stages, it will not be able to control the system properly.
- The sensor wires can be extended up to 500' by splicing with 2-conductor shielded cable (Belden #8760 or equivalent (#18/2)).
- Do not run sensor wire in conduit with line voltage.
- Temperature sensors have no polarity. Connect the wires from the sensor to the BSC terminals marked *TEMP- A1, A2*.
- Connect the shield to the circled terminal *TEMP-A2* with one of the sensor wires.
- Cut the shield wire at the sensor end.

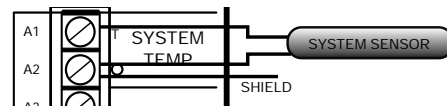

SYSTEM PRESSURE

- The BSC is designed to be connected to a 0-30PSI pressure transducer (511-624-643). However, it can be used with a variety of 4-20mA transducers. See Sensor Type selection on page 13.
- Locate the sensor on the main supply header where it will register the output of all the stages. If the sensor can not read the output of all the stages, it will not be able to control the stages properly.
- Attach a 1/4" isolation tube (pigtail) to the header.
- Screw the pressure sensor to the pigtail. The sensor has 1/4" NPT female threads.
- Pressure sensor wires can be extended up to 500' by splicing with 18 gauge shielded wire.
- Do not run sensor wire in conduit with line voltage.
- **PRESSURE SENSORS HAVE POLARITY.** Cut the Green wire, White wire, and the clear tube. Only the Red and Black wires should be connected.
- Connect the Red wire from the pressure transducer to terminal *PRESS - A6 (+)*.
- Connect the Black wire from the pressure transducer to terminal *PRESS - A5 (S)*.

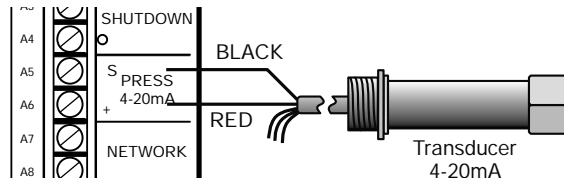

WIRING AN EXTERNAL SET POINT (4-20MA INPUT)

- The BSC can utilize an external set point as a 4-20mA signal from an Energy Management System (EMS) or any other signal source.
- A system sensor must be installed as described in the previous section.
- The External Set Point must be set up correctly (See EMS Input Mode and External Set Point in the Startup menu on page 13). These settings will allow the BSC to read the 4-20mA input signal and adjust the set point based on its external set point setting.
- The BSC can source the current for the 4-20mA input. It provides an excitation voltage of 24VDC. If using the BSC to source the current, attach the (+) side of the 4-20mA input to the BSC *EMS terminal marked +*. Attach the (-) side of the 4-20mA signal to the *EMS terminal marked SIGNAL*.
- If the EMS sources the current (provides the excitation voltage), attach the (+) side of the 4-20mA input to the BSC *EMS terminal marked SIGNAL*. Attach the (-) side of the 4-20mA input to the *EMS terminal marked SHIELD*.

EMS Sourcing Current

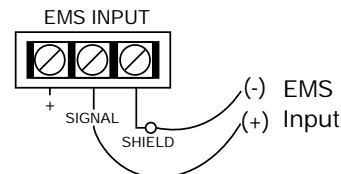

BSC Sources Current
24VDC Excitation Voltage

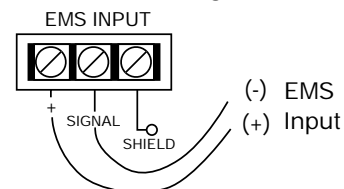

WIRING THE SHUTDOWN

- This feature can be used whenever it is desirable to turn off the BSC from a remote location using another controller.
- A typical use for this feature would be to turn off all boiler stages when an EMS panel no longer requires heat in the system.
- When the Shutdown feature is enabled by closing a dry-contact, all active stages will immediately modulate down to low. They will remain in low for the Soft-Off period (See Soft-Off Delay on page 27) and then, turn off.
- If the System Output relay was active, it will remain active until the System Run-On Delay is over, then it will also turn off.
- The Shutdown signal must be a dry-contact only. No voltage can be placed across the *SHUTDOWN* terminals.
- Bring the two wires from the dry-contact to the terminals marked *SHUTDOWN- A3, A4*.

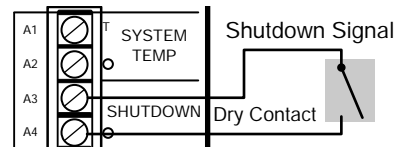

BSC Installation and Operation Manual

WIRING THE SYSTEM PROVE

- The System Prove feature is provided to check the system component operation status.
- A typical use of this feature is to check for water flow before firing any boiler stages. When there is a call for heat, the System Output relay activates the system pump. When the pump establishes flow, a flow switch closes the *SYSTEM PROVE* input terminals. Only then, can the BSC activate and modulate the boilers as required to hold the set point.
- If the *SYSTEM PROVE* input is open on a call, the BSC will enable only the System Output. All Stage outputs will be off when the *SYSTEM PROVE* input is open.
- A factory installed jumper provides the System Prove signal. Do not remove the jumper unless it will be replaced by a Prove signal.
- The System Prove signal must be a dry-contact only. No voltage can be placed across the *SYSTEM PROVE* terminals.
- Bring the two wires from the dry-contact to the terminals marked *SYSTEM PROVE - A9, A10*.

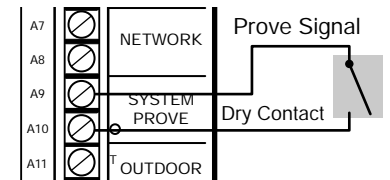

⚠ WARNING

Do not remove the factory installed System Prove jumper unless it is replaced by a System Prove signal. If the *SYSTEM PROVE* input is not closed/shorted, the BSC will NOT activate the stages.

The *SYSTEM PROVE* input cannot be used as a safety limit. All equipment must have its own certified limit and safety controls as required by code.

WIRING THE LOCKOUT INPUTS

- The BSC will not activate or modulate any Stage in Lockout. A closure across the pair of *LOCKOUT INPUT* terminals informs the BSC that the boiler stages have encountered a safety limit and cannot be restarted.
- The Lockout signal is not a safety feature. However, use of the Lockout will drastically improve the BSC's set point control performance in the event of a stage going into lockout when encountering a safety limit.
- A pair of *LOCKOUT INPUT* terminals is provided for each stage.
- The Lockout signal must be a dry-contact closure from the boiler being controlled by that stage's modulating output. No voltage can be placed across the terminals.
- Wire the Lockout signals to their respective *STAGE* terminals.

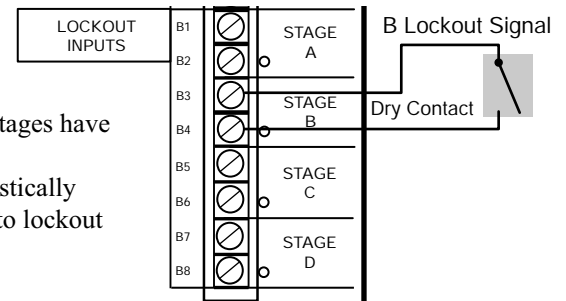

⚠ WARNING

The *LOCKOUT INPUTS* cannot be used as safety limits. All equipment must have its own certified limit and safety controls as required by code.

WIRING A SETBACK

- To use the Setback, the EMS Input mode must be set to Setback. See page 13.
- The Setback feature can be used to switch the BSC to a lower Set Point when less load is required during the night or on the weekends when a building is unoccupied, but a minimum level of heat is still required.
- The Setback feature cannot be used with External Set Point (4-20mA EMS input), or Reset operation.
- The Setback signal is wired into the *EMS* terminals (+) and (*SIGNAL*).
- The Setback signal must be a dry-contact only. No voltage can be placed across the *EMS* (+) and *SIGNAL* terminals.
- When the *Setback terminals* are shorted, the Setback is enabled and the BSC will hold the lower Set Point. The lower Set Point will appear on the main display indicating this condition "Stb= 150F".
- When the short is removed, the BSC will revert to the higher saved Set Point.

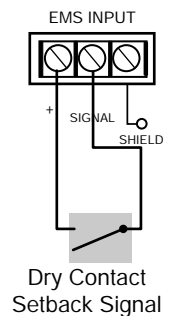

⚠ ALERT

The Setback is not equivalent to the 4-20mA input, even though both wire into the *EMS* terminals. The 4-20mA input requires 4-20mA source that changes the Set Point in one degree increments. The Setback provides lower Set Point.

OUTPUT WIRING

WIRING THE SYSTEM OUTPUT

System Output Operation in Set Point Mode

- The System relay will energize whenever there is a call for output and the Shutdown feature is not active.
- Until the *SYSTEM PROVE* input is shorted no Stages will be activated. If a Prove is not required, the factory-installed jumper should remain connected.
- The System will remain energized while any Stage is active.
- When the last Stage relay turns off, and if the Outdoor Cutoff was set "10" or the outdoor sensor was not installed, the System output can remain energized for the period set by the System Run-On.
- A typical use of the System output is to activate a system pump starter. The pump can run whenever there is a call for heat. However, when heat is no longer required, the pump will stay active for Run-On Delay to remove the residual heat from the boilers.
- For the System output to function, a relay must be installed. The relay is capable of switching 1A pilot duty at 120VAC (approximately 1/3HP).

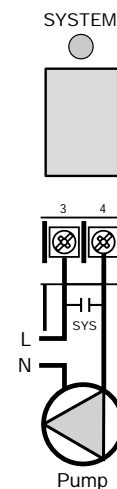

System Output Operation in Reset Mode

- The System output relay will energize whenever the outdoor temperature is below the Outdoor Cutoff.
- The System will remain constantly energized while the outdoor temperature is below the Outdoor Cutoff.
- When the outdoor temperature rises 2°F above the Outdoor Cutoff, the System output will remain energized for the System Run-On and then, turn off.

Wiring the System Output

- The System output has one Normally Open (N.O.) dry-contact relay. It does not source any power.
- Class 1 voltage wiring must enter the enclosure through a different knockout from any Class 2 voltage wiring.
- Each N.O. contact is capable of switching 1A pilot duty at 120VAC (approximately 1/3HP).

WIRING THE STAGE OUTPUTS

- Each stage has an operating limit relay output in addition to the modulation output. The operating limit output can be used when a boiler requires an activation signal through its limits. However, some newer boilers utilize the modulation signal to manage this function. In this case operating limit outputs are not used.

Installing the Operating Limit Output Relays

- Each operating limit output stage (*A* through *D*) that is to be used must have a relay installed in the socket for the limit output to function.
- To install a relay, orient the pins to match the socket and then press it gently into the appropriate socket.

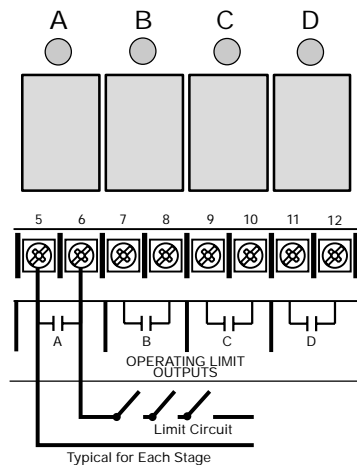

Wiring the Stage Outputs

- Each Stage output (*A* through *D*) has one Normally Open (N.O.) relay contact.
- The N.O. contacts are dry-contacts only. They do not source any voltage.
- Each N.O. contact is capable of switching 1A pilot duty at 120VAC.
- Wire the N.O. relay contacts in series with the unit's limit circuit.
- Class 1 voltage wiring must enter the enclosure through a different knockout from any Class 2 voltage wiring.

WIRING TO 135Ω MODULATING MOTORS

- The BSC can be equipped to operate up to four 135 Ω modulating motors (BSC ordered with 135 Ohm Output boards.) See Modulating Output Cards on page 10.
- Terminals C1, C4, C7, and C10 on the BSC must be connected to the modulation decreasing terminals on the burners (Blue/Black modulating wires).
- Terminals C3, C6, C9, and C12 on the BSC must be connected to the modulation increasing on the burners (White modulating wires).
- Terminals C2, C5, C8, and C11 on the BSC must be connected to the modulation common terminals on the burners (Red modulating wires).

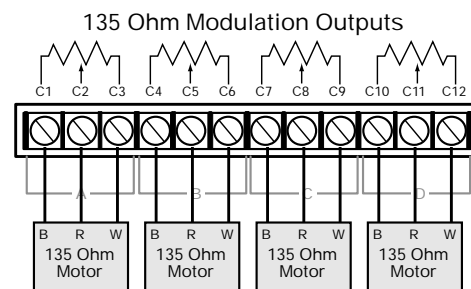

BSC Installation and Operation Manual

WIRING TO 4-20 MA MODULATING MOTORS

- The BSC can be equipped to operate up to four 4-20 mA modulating motors (BSC ordered as C/V (Current/Voltage)). See Modulating Output Cards on this page.
- To program the control for 4-20 mA output, see Output Type on page 16.
- Apply the supplied label marked Current/Voltage below the modulating terminals.
- The BSC sources 24VDC excitation voltage for the 4-20mA signal.
- Terminals C2, C5, C8, and C11 on the BSC must be connected to the modulation Signal (+) terminals on the burners.
- Terminals C1, C4, C7, and C10 on the BSC must be connected to the modulation Common terminals on the burners.
- In some installation where the boilers do not require a separate activation output signal, it might be beneficial to utilize the limit output relay to make or break the current signal. In this case, wire the current signal as indicated in the diagram.

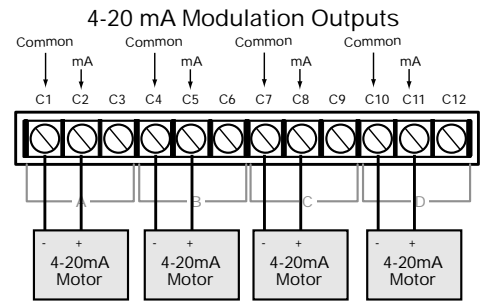

WIRING TO VOLTAGE MODULATING MOTORS

- The BSC can be equipped to operate up to four 0-5 V, 0-10V, 1-5V, or 2-10V modulating motors (BSC ordered as C/V (Current Voltage).)
- Apply the supplied label marked Current/Voltage below the modulating terminals.
- To select the range, 0-5V, 0-10V, 1-5V or 1-10V, see Output Type on page 16.
- Terminals C1, C4, C7, and C10 on the BSC must be connected to the modulation Ground terminals on the burners.
- Terminals C3, C6, C9, and C12 on the BSC must be connected to the modulation Voltage (V+) terminals on the burners.
- In some installation where the boilers do not require a separate activation output signal, it might be beneficial to utilize the limit output relay to make or break the voltage signal. In this case, wire the voltage signal as indicated in the diagram on the right.

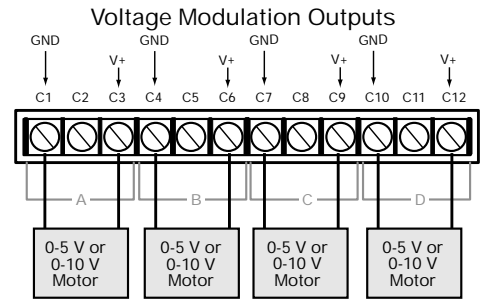

Current Modulation Outputs in series with Limits

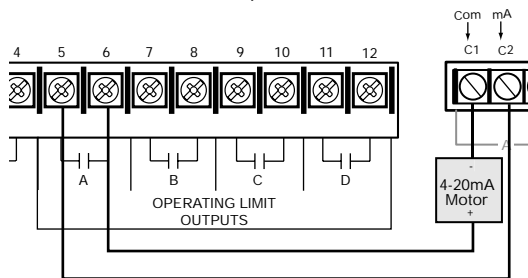

Voltage Modulation Outputs in series with Limits

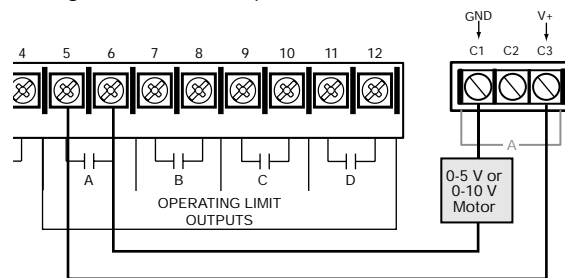

MODULATING OUTPUT CARD

- Every two modulating boiler outputs are controlled by one Modulating Output Card. A and B are controlled by the same Modulating Output Card while C and D are controlled by a different Modulating Output Card.
- The cards are installed on the back of the BSC main board.
- There are two types of cards available:
 - 135Ω Cards Operates two 135 Ohm modulating motors.
 - Current/Voltage Cards: operates 4-20mA, 0-10V, 0-5V, 2-10V, or 1-5V modulating motors. You can select only one output signal per card.
- The BSC comes with its Modulating Output cards installed. However, if ordering an Extension panel, you must add the Modulating Output Cards needed as they do not come with the Extension.

BACNET COMMUNICATION WIRING

- The BSC control comes either as a Standard without any communication or with BACnet communication.
- Any BSC with BACnet communication control package has a BACnet Communication Board installed on the back of the BSC main board.
- Connect the BACnet CAT5 Ethernet cable coming from the network to the BACnet RJ45 Communication socket on the BSC communication board.
- Set the BSC BACnet Network Settings as described on page 28.

Modulating Output Cards on Back of Control

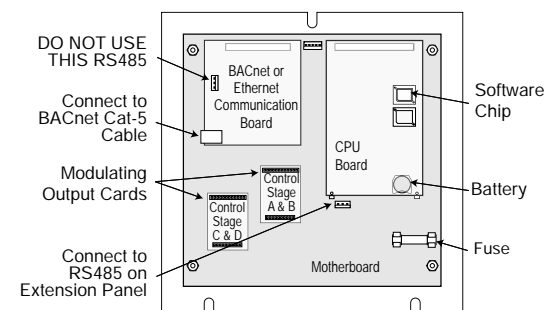

BACnet Communication Connection to Back of Control

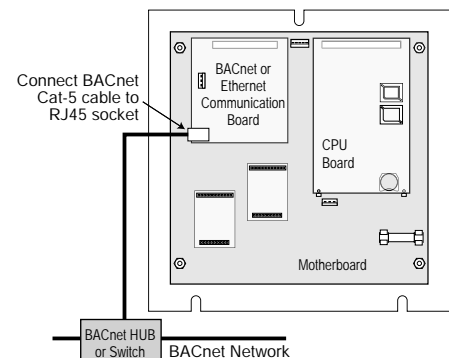

WIRING THE BSC TO EXTENSION PANELS

- When an application requires more than 4 modulating stages, up to two Extension panels can be used to add a total of 16 stages. Each extension has 8 stages with lockout inputs. The BSC can manage the Extension panels using an RS485 connection.
- The RS485 connection is a cable with two rounded ends. Each end fits a socket on the BSC or the Extension enclosure. All necessary cables come with the extension panel.
- An additional cable with RS485 flat connector on one end and a round connector on the other end is used to connect the RS485 plug on the main BSC board to the enclosure.
- Prior to starting the BSC, make sure that all Extension panels are connected, wired, and powered. So, when the BSC is powered, it will detect all available stages, including the stages on the Extensions.
- If Extension panels were connected after the BSC Startup, the BSC must be re-powered to detect the Extension stages.
- The connection from the BSC to the Extensions can be either in parallel or in series. See the following diagrams for details.

⚠ WARNING

DO NOT use the RS485 connector on the BACnet communication board to connect to the Extension. Rather, use the RS485 on the main PCB board.

- Note that, Extension panels do not come with Modulating Output Cards. The Output Cards must be purchased separately.

DIFFERENT WAYS OF CONNECTING BSC TO TWO EXTENSION PANELS

Connecting two Extension Panels in Series

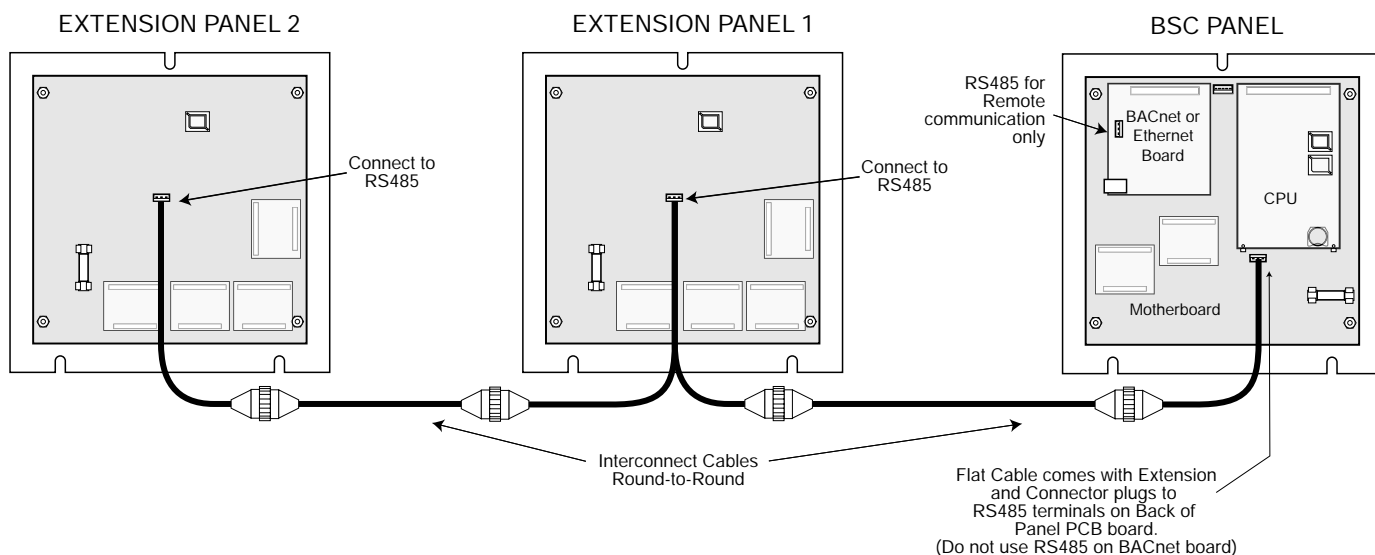

Connecting two Extension Panels in Parallel

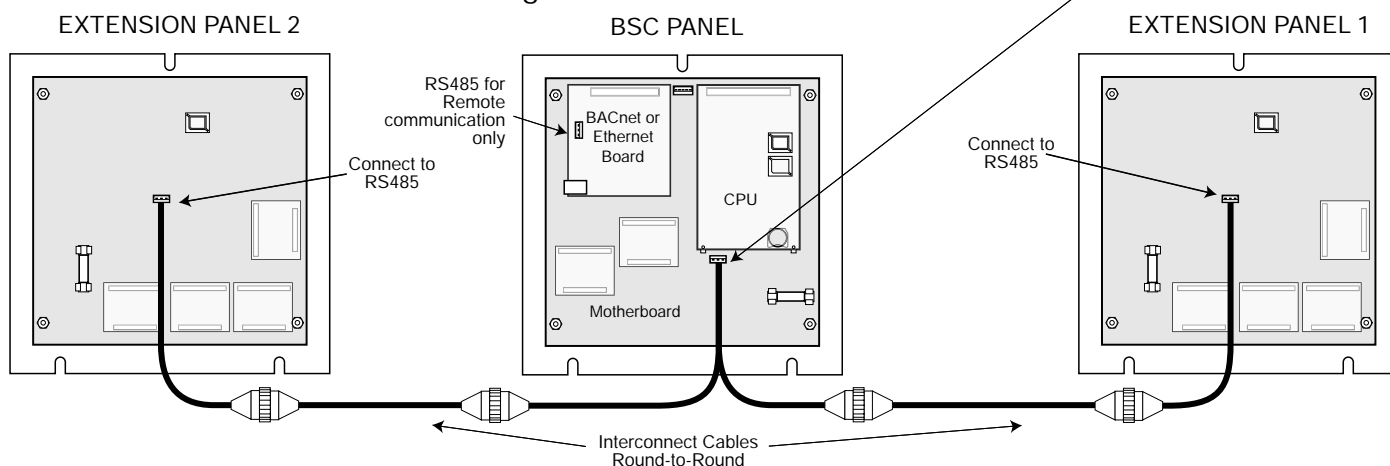

USING THE MENUS

MENU BASICS

- The menus are in English and will guide you through the settings.
- To change a selection, rotate the black knob marked *ADJUST* and *PRESS TO SELECT* (*ADJUST/SELECT*).
- A pointer in front of a menu line indicates that it is the one currently selected.
- When the pointer is on the same line as the item to be selected, press the black *ADJUST/SELECT* knob. This will either save the selection, or bring up a new screen to make further changes to that menu item.
- The *BACK* button will return you to the previous screen without saving any changes.
- The *STAGE* button will bring the Stage menu to the display. See Stage Settings on page 24.
- When in the Stage Menu, the *PREV.* button will scroll through the Stages in a descending order. See Moving Around the Stages on page 24.
- When in the Stage Menu, the *NEXT.* button will always bring the display to the Mode menu of the current stage. See Moving Around the Stages on page 24.
- To change a selection, rotate the *ADJUST/SELECT* knob. Rotating the knob will cause both the old and new value will be displayed.
- The *BACK* button will return you to the previous screen without saving any changes.
- After changing a value, press the *ADJUST/SELECT* knob. This will save the selection to memory and return you to the previous menu.
- To view the BSC's startup settings, start with the default display and then press and hold press the *ADJUST/SELECT* knob for at least three seconds. While holding the *ADJUST/SELECT* knob down, pressing the *NEXT* button will scroll the display through the different settings including the communication settings.



This pointer shows the currently selected item



The BACK button returns to a previous menu without changing the selection



Pressing
The ADJUST/SELECT knob saves the selection to memory and returns to a previous menu



Rotating
The ADJUST/SELECT knob moves the pointer up and down selections

THE MAIN DISPLAY

- The main display screen may have different values in the top two lines depending on the application. The **OD** represents the current Outdoor Sensor value. The **SYS** represents the current System Sensor value.
- The second line of the display will display any messages that is pertinent to the current operation.
- The third line shows the four stages. The Lead Stage will be in brackets. For example, the Lead Stage shown is **<A>**.
- The last line shows the modulation status of each stage. See possible stage modulation status below.

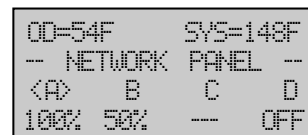

DISPLAY STAGE MODULATION STATUS

The BSC boiler modulation status gives immediate access to each boiler status. The following list shows all possible boiler status:

- --- The stage is off due to no call for heat/cool.
- 97% The stage is modulating at the indicated percentage.
- ON Stage Mode is set to ON and boiler is firing at 100% (boiler is in bypass). See Mode on page 24.
- OFF Stage Mode is set to OFF and boiler stage is unavailable or boiler does not exist. See Mode on page 24.
- m95% Stage Mode is set to Manual and set to the 95 percent modulation. See Mode on page 24.
- C/E The stage on Extension panel is NOT communicating back to the BSC. See connecting extensions on page 11.
- L/O The stage Lockout input terminals are shorted. See Lockout on page 8.

DISPLAY MESSAGES

The BSC normal display layout reserved the second line from the top for message indications. The following is a list of the most common Message Display Line information:

- Network Panel The control has a communication package installed and the display is dimmed (Screen Saver Mode).
- Shutdown Active The Shutdown Terminals are Shorted. No stages will be active. See Shutdown on pages 7.
- Shutdown by EMS The EMS is below 2mA or above 22mA. See EMS input and External Set Point pages 13.
- Purge Delay: 23 The current boiler is in purge cycle and the remaining purge time in seconds is 23. See Purge Delay on page 20.
- Lag Delay: 123 The lead stage is at 100% and the remaining purge time to start the lag boiler in seconds is 123. See Lag Delay on page 20.

- Holding Until 150°F The Lead stage is in Last-Stage-Hold. This example shows that the lead stage will turn off when system temperature reaches 150°F. See Last-Stage-Hold on page 21.
- System Run-On: 46 The System relay is ON for the System Run-On Delay. This example shows that it will remain in System Run-On for an additional 46 seconds before turning off. See System Run-On on page 21.
- Waiting for Prove The System relay is ON and the prove terminals are open before the lead boiler relay can energize. See Prove wiring on page 8.
- Prove Failure After boilers have run for a while, Prove signal was opened. All boiler relays will de-energize. However, the System relay will remain energized. See Prove wiring on page 8.

SYSTEM STARTUP

STARTUP SEQUENCE

- When powered, the BSC performs a self test diagnostics on its components.
- After the test have been successfully completed, the BSC will initialize the BSC using a descending counter starting from 10.
- On the first power up, the System Startup menu screens will appear after the initialization is complete. If it doesn't, the BSC has already been configured. To check the configuration, or to make changes, follow the procedure on the System Startup menu.
- The System Startup menu determines the how BSC should control the system. That is why you the user must go through several warning screens to indicate the importance and severity of their changes.
- Press the *ADJUST/SELECT* knob once on each screen to accept its value and move to the next setting.

SENSOR TYPE

Set Point: (°F, °C), Pressure: (15psi, 30psi, 100psi, 200psi, 300psi), Reset: (°F, °C)

Default: Set Point °F

SELECT: MENU/<System Startup>/.../Sensor Type

- Reset mode requires an outdoor sensor to be connected to terminals A11 and A12. DO NOT select Reset without an outdoor sensor.
- The same Weil McLain temperature sensor can display in either °F or °C.
- If °F is selected, all temperatures and settings will be displayed in degrees Fahrenheit and the BSC will operate as a Set Point Control in degrees Fahrenheit.
- If °C is selected, all temperatures and settings will be displayed in degrees Celsius and the BSC will operate as a Set Point Control in degrees Celsius.
- Set point mode does not require an outdoor sensor. If an outdoor sensor is connected in any of the Temperature or Pressure Set Point modes it will be used only as an outdoor cutoff measurement.
- The BSC will only measure the output terminals of the system sensors selected from tis menu.

```

--- SENSOR TYPE ---
P °F
 °C
 15psi
 30psi
100psi
200psi
300psi
Reset°F
Reset°C
    
```

EMS INPUT MODE

Setback, EMS Control

Default: Setback

SELECT: MENU/<System Startup>/.../Sensor Type/EMS Input Mode

(Not Available In Reset Sensor Types)

```

- EMS INPUT MODE -
P Setback
 EMS Control
    
```

Setback

- It allows the Set Point to be adjusted manually.
- If desired, a dry-contact switch can be wired across the *EMS INPUT* terminals (*SIGNAL* and *+*) to allow the panel to hold a lower Set Point when less load is required.
- When selecting Setback, there is no requirement for any wiring across the *EMS INPUT* terminals. **DO NOT** select *EMS-Control* unless your system meets the requirements below.

External Set Point (4-20mA EMS Input)

- For this option, an EMS system must provide a 4-20mA signal to automatically change the Set Point based on pre-programmed system parameters. See Wiring External Set Point on page 7.
- An active signal must be wired into the BSC *EMS* terminals. If the BSC does not receive a signal between 2mA and 22mA, it will **NOT** activate any stages. The display will indicate "Shutdown by EMS" on the display message line.

MENU SETTINGS

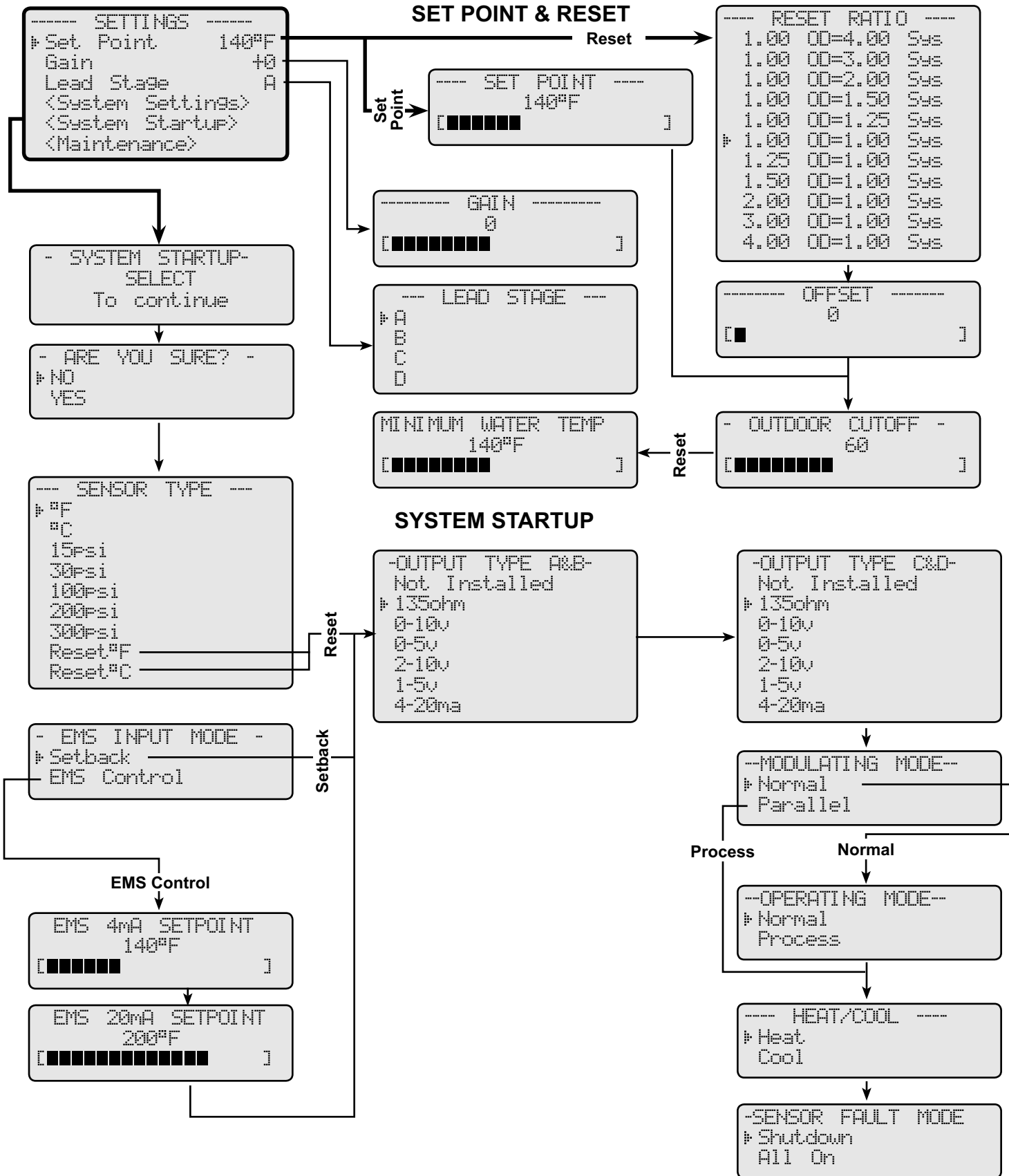

MENU SETTINGS CONTINUED

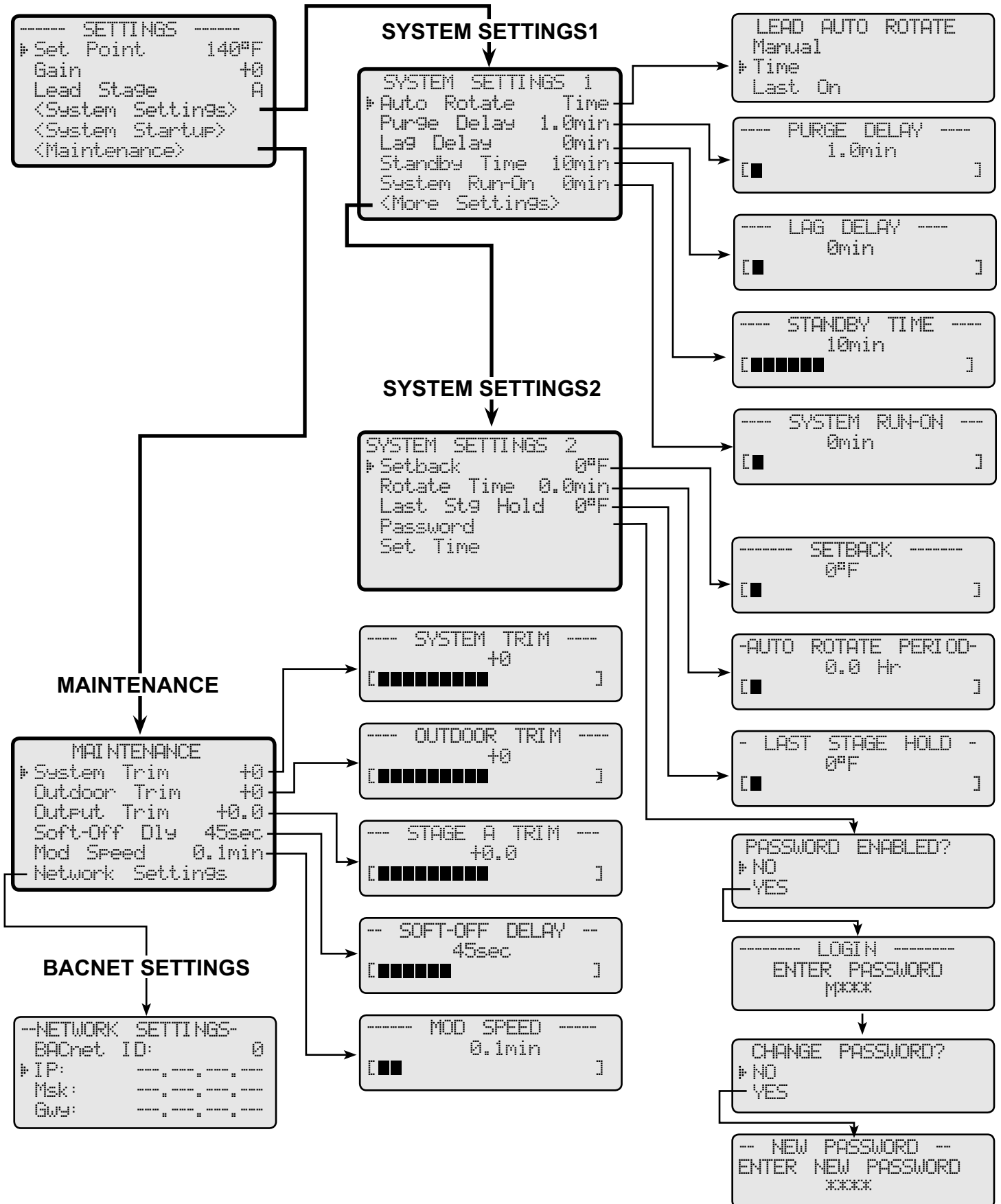

BSC Installation and Operation Manual

4 & 20MA SET POINTS

4mA Adjustable from 70°F/21°C to 200°F/93°C

Default: 140°F/ 60°C

20mA Adjustable from 90°F/32°C to 240°F/116°C

Default: 200°F/ 93°C

SELECT: MENU/<System Startup>/.../Sensor Type/EMS Input Mode/EMS 4mA SP

(Available In EMS Control Only)

- This allows the BSC to receive an external set point from an EMS/BMS system.
- You must select the set points at 4mA (min) and 20 mA (max).
- The 4mA and 20mA can be set to any temperature/pressure.
- Either 4 or 20mA can be the bottom (or top) of the Set Point range.

```
EMS 4mA SETPOINT
140°F
[■■■■■■■]
```

```
EMS 20mA SETPOINT
200°F
[■■■■■■■■■■■■■■■■■■■■]
```

OUTPUT TYPE

135Ω, 0-10V, 0-5V, 2-10V, 1-5V, 4-20mA

Default: 0-10V, 135Ω

SELECT: MENU/<System Startup>/.../Output Type A&B

- The BSC has two Modulating Output Cards, one for every two stages.
- The Output Cards can be either 135Ω Cards for 135 ohm modulating motors or Current/Voltage Cards for current or voltage signal operating motors. Each card controls two boilers (A & B) or (C & D). The Output Cards normally come pre-installed on the back of the control main board of the BSC. See Output Cards on page 10. However, if an extension is installed for additional stages, the installer must purchase and install its Output Cards separately.
- Both output cards must be programmed for the appropriate mode of operation.
- If no output card is installed, the "Not Installed" option will automatically be selected by the control.

```
-OUTPUT TYPE A&B-
Not Installed
▶ 135ohm
0-10v
0-5v
2-10v
1-5v
4-20ma
```

135Ω OUTPUTS

- Output Type 135Ω cannot be adjusted. It will automatically be selected by the control if the corresponding Output Card is installed.

4-20MA, 0-5V, 0-10V, 1-5V, OR 2-10V OUTPUTS

- Outputs can be configured to 4-20mA operation (current) or the voltage range can be selected (0-5V, 0-10V, 1-5V, 2-10V).
- Check the modulating motor to determine its control requirements.
- Select the appropriate Output Type for stages A & B. The BSC will then automatically bring up the screen for stages C & D.
- If different types of burners are being used, stages C & D can be selected to have a different Output Type from stages A & B.

⚠ ALERT
Connect the extension panels, if needed for additional stages, prior to setting the Output Type. As the BSC will only show the output stages it can detect.

MODULATING MODE

Normal, Parallel

Default: Normal

SELECT: MENU/<System Startup>/.../Output Type C&D/Modulating Mode

- Some modulating boilers perform better as their modulation increases. For these units, it is advantageous to run one unit at high modulation than several units at lower modulation. If the units used are of this type, select Normal. This is the recommended setting for typical steel and cast iron boilers or boilers with low turndown ratios.
- There are many condensing boilers that run more efficiently at lower modulation. If it is more energy efficient to run several units at lower modulation than one at high, select Parallel. This is typically used on water-tube boilers, low mass boilers, or burners with high turndown ratios.

```
-MODULATING MODE -
▶ Normal
Parallel
```

OPERATING MODE

Normal, Process

Default: Normal

SELECT: MENU/<System Startup>/.../Modulating Mode/Operating Mode

(Available with Normal Modulating Mode Only)

- Most heating applications do not experience rapid changes in the system. For these systems, it is best to adjust the modulation based on the rate of system rise or fall. This PID type of algorithm will help prevent short cycling of the stages, reduce thermal shock, and maintain an accurate system temperature/pressure. If your equipment is of this type, select Normal.
- Systems that run for process may experience large changes in load almost instantaneously. In Process mode, the BSC will react immediately to load changes. Large load changes may cause stages to be short cycled, as the BSC can enable and disable stages within seconds.

```
-OPERATING MODE -
▶ Normal
Process
```

HEAT/COOL MODE

Heat, Cool

Default: Heat

SELECT: MENU/<System Startup>/.../Modulating Mode/Operating Mode/Heat-Cool

- The BSC offers two modes, Heating and Cooling. In Heating, the BSC will modulate stages when the system is below the set point. In addition, the system relay will energize when the outdoor temperature is at or below the Outdoor Cutoff setting.
- In Cooling, the BSC will modulate stages when the system is above the set point. In addition, the system relay will energize when the outdoor temperature is at or above the Outdoor Cutoff setting.

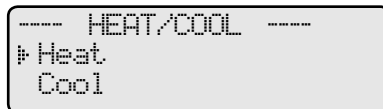

SENSOR FAULT

Shutdown, All On

Default: All On

SELECT: MENU/<System Startup>/.../Sensor Fault Mode

The Sensor Fault will determine the operating status of all output stages that are set to Auto when a sensor reads Short or Open.

RESET MODE

- When All-On is selected, the BSC will turn all stages On to a 100% when the System or Outdoor reads Short or Open and the Outdoor is below Outdoor Cutoff.
- When Shutdown is selected, the BSC will turn all stages Off when either System or Outdoor sensor reads Short or Open.

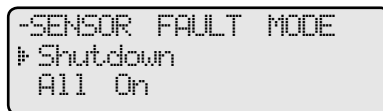

SET POINT MODE

- When All-On is selected, the BSC will turn all stages On to a 100% when the System sensor reads Short or Open.
- When Shutdown is selected, the BSC will turn all stages Off when the System sensor reads Short or Open.
- The Outdoor Sensor Short or Open status will not affect the control operation in Set Point mode.

OPERATING SETTINGS

SET POINT

See **Set Points and Defaults Table on page 22.**

SELECT: MENU/<System Settings>/.../Sensor Type

- The Set point is the temperature/pressure the BSC will use to control the system.
- The BSC will add, subtract, modulate, or hold the stages to maintain the system temperature/pressure around the Set point.
- The system is expected to fluctuate around the set point. The amount of fluctuation depends on the System and Stage Settings.
- If an Outdoor Sensor was connected, pressing the ADJUST/SELECT button will continue to the Outdoor Cutoff setting option.
- If the EMS Mode was Enabled (see page 13), the Set Point will be set by the EMS/BMS system and will be available as a read only.
- The range of Set Point in the EMS is set in the Startup menu at 4mA and 20mA. See EMS Set Point on page 16.
- Any reading below the 2mA or above 22mA will indicate a "Shutdown by EMS" message on the Message Line.
- The Set Point will vary linearly with the 4-20mA signal from the EMS signal.

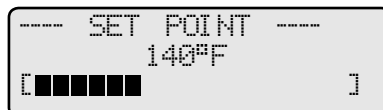

OUTDOOR CUTOFF TEMPERATURE

Adjustable Off, from 20°F/-7°C to 100°F/38°C, On

Default: 60°F/16°C

SELECT: MENU/Set Point/Outdoor Cutoff

in Set Point

SELECT: MENU/Set Point/Offset/Outdoor Cutoff

in Reset

- In Outdoor Reset mode, Outdoor Cutoff will always exist. However, in Set Point mode, if the outdoor sensor is installed, the Outdoor Cutoff screen will automatically appear after the temperature Set Point has been selected.
- In heating, when the outdoor temperature falls to the adjustable Outdoor Cutoff temperature, the BSC will control the stages to hold the calculated temperature/pressure.
- When the outdoor temperature rises to the Outdoor Cutoff plus a 2°F differential, the BSC will modulate the all stages down. Then, run the Soft-Off delay while blinking the stages modulation status then turn them off. The System relay will remain energized for the Run-On delay and then de-energize.
- In cooling, when the outdoor temperature rises to the adjustable Outdoor Cutoff temperature, the BSC will control the stages to hold the calculated temperature/pressure.



BSC Installation and Operation Manual

- In addition, the Outdoor Cutoff can be set to ON or OFF. In the ON option, the System Relay will run regardless of the Outdoor temperature and the stages will modulate to hold the target set point.
- In the OFF position, the system will always be off and all stages will be off as well.

RESET RATIO

(1.00°OD : 4.00°Sys) to 12 (4.00°OD : 1.00°Sys) Default: 1(1.00°OD : 1.00°Sys)

SELECT: MENU/Set Point/Reset Ratio

In Outdoor Reset Only

- The Reset Ratio determines how the system Target temperature will vary based on the outdoor temperature. With any of the ratios, the colder it becomes outside, the hotter the temperature of the system water.
- With a 1.00 (OD):4.00 (SYS) ratio, the System water temperature (SYS) will increase rapidly as the outside temperature falls, hitting 240°F at 35°F outside temperature. With a 4.00 (OD):1.00 (SYS) ratio, the System temperature (SYS) will increase slowly as the outside temperature falls. Even at -30°F, the system water will only be 125°F, and at 22°F outside, the system water will be 112°F. Such a low Reset Ratio might be used with radiant floor heating applications.
- With most baseboard heating applications, a 1.00 (OD):1.00 (SYS) setting is a good place to start. Using a 1.00 (OD):1.00 (SYS) ratio, for every degree the outside temperature falls, the system water temperature is increased one degree.
- If required: **Adjust the RESET RATIO in cold weather.** If the ambient building temperature are cold in cold weather, move the ratio to a higher selection. That is, if 1.00 (OD):1.00 (SYS) was initially selected, change the selection to 1.00 (OD):1.25 (SYS). If the building temperature is too warm in cold weather, move the ratio to a lower selection. That is, if 1.00 (OD):1.00 (SYS) was initially selected, change it to 1.25 (OD):1.00 (SYS).
- After selecting the Reset Ratio, pressing the *ADJUST/SELECT* button will switch to the Offset setting option.

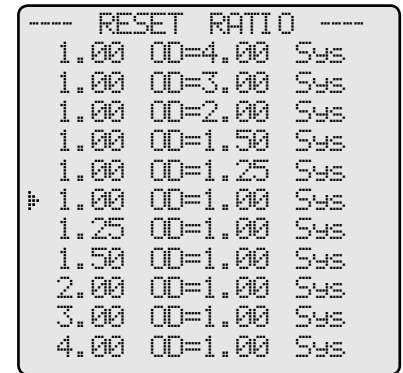

OFFSET

Adjustable from +40F°/+22C° to (-40F°/-22C°)

Default: 0F°/0C°

SELECT: MENU/Set Point/Offset

in Outdoor Reset only

(Available with Reset Modes Only)

- The Offset setting moves the Reset Ratio curve vertically. This means that, regardless of the Outdoor temperature, or the Reset Ratio that has been selected, when the Offset setting is changed, that change is directly added to or subtracted from the calculated temperature. For example, if the Set Point temperature was 130°F and the Offset was changed from 0° to 10° (an increase of 10°), the Set Point would increase to 140°F.
- The Offset setting does not change the ratio selection. For instance, with 1.50 (OD):1.00 (SYS) Reset Ratio, the System water temperature will always increase one degree for every 1.5 degree change in the Outdoor temperature. What the Offset does is add or subtract a constant temperature value.
- If required: **Adjust the Water Offset in mild weather.** If the ambient building temperatures are too warm in the mild weather, decrease the Offset. If the ambient building temperatures are too cold in the mild weather, increase the Offset. The rule of thumb for baseboard radiation is to change the Offset 4°F for every 1°F you wish to change the building temperatures. In radiant heat applications, change the Offset 1°F or 2°F for every 1°F you wish to change the building temperature.

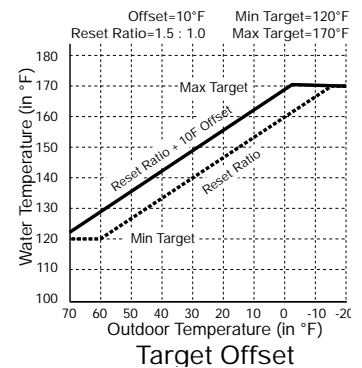

MINIMUM WATER TEMPERATURE

Adjustable from 70°F/21°C to 180°F/82°C

Default: 140°F/60°C

SELECT: MENU/Set Point/Reset Ratio/Offset/Outdoor Cutoff/Min Wtr Temp

(Available with Reset Modes Only)

- The Minimum Water Temperature must be set to the boiler manufacturer's specification. The BSC will calculate the Set Point based on the Outdoor temperature, the Reset Ratio, and the Offset value. The BSC will control all boilers to hold either the Set Point temperature, or the Minimum Target, whichever is higher.

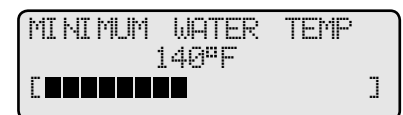

GAIN/THROTTLE

Adjustable from -10 to +10

Adjustable from 1.0 to 10.0

SELECT: MENU/Gain

Default: 0 in Normal Operating Mode

Default: 5 in Process Operating Mode



NORMAL OPERATING MODE

- In Normal Operating Mode (See page 16), the Gain adjusts the aggressiveness of the BSC PID logic to control how much modulation is changed when the system temperature/pressure is different from the Set Point. It is based on the rate of change.
- A Gain of 0 is a good starting point for all systems.
- If during normal load conditions, the system temperature/pressure tends to oscillate significantly, decrease the Gain by two numbers (for example, from 0 to -2). Wait for at least 15 minutes before evaluating how the change has affected the system.
- If during normal load conditions the system temperature/pressure tends to remain consistently below the Set Point (or consistently above the Set Point), increase the Gain by two numbers (for example, from 0 to 2). Wait for at least 15 minutes before evaluating how the change has affected the system.

PROCESS OPERATING MODE

- The Gain acts as a throttling range around the Set Point.
- When the actual temperature/pressure is equal to the Set Point, the lead stage will be at 100% modulation.
- Each throttling range above or below the Set Point controls one stages modulation linearly from 0 to 100%.
- The Process Gain Table below shows the relationship between the Gain and stage modulation.
- The Process Gain Table does not show all the possible modulation values. The table is for example only. The BSC will control the modulation in one percent increments based on the Set Point and Gain value.

PROCESS GAIN/THROTTLING RANGE TABLE

System Temperature	Stages Modulation
More than 1 x Gain above Set Point	Lead Stage is OFF
1 x Gain above Set Point	Lead Stage at 1%
0.5 x Gain above Set Point	Lead Stage at 50%
At Set Point	Lead Stage at 100%
0.5 x Gain below Set Point	Lead Stage at 100%, 1 Lag at 50%
1 x Gain below Set Point	Lead Stage at 100%, 1 Lag at 100%
2 x Gain below Set Point	Lead Stage at 100%, 2 Lag at 100%
3 x Gain below Set Point	All Stages at 100%

LEAD STAGE

Adjustable from A through D

Default: A

SELECT: MENU/Lead Stage

- The Lead Stage is the first stage brought on when output is required.
- The Lead Stage can be rotated manually or automatically. The automatic rotation is recommended.
- The current Lead Stage is shown in brackets on the display. <A>
- Only stages that are set to Auto Mode can be Lead. Therefore, not all stages may be available when manually selecting a new Lead Stage.

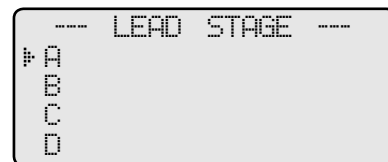

LEAD AUTO ROTATE

Manual, Time, Last-On

Default: Time

SELECT: MENU/System Settings/Auto Rotate

- The Lead Stage will always be the first stage activated when there is a call for output.
- Automatically rotating the Lead among the active stages promotes more even wear on the Stages and can help prolong the life of each unit.
- The Lead Stage is shown on the main display in brackets. <A>

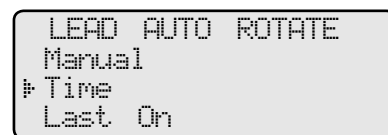

BSC Installation and Operation Manual

MANUAL

- In Manual, whichever stage is presently the Lead Stage will remain the Lead Stage.

TIME

- If Time is selected, a second screen will allow the adjustment of the Auto Rotate Period. If 24 Hours (default setting) was selected, the first rotation will take effect after 12 hours if the Time was not set. However, if the Time was set, the rotation will always take place at 2:00AM. The following rotations will take place every 24 hours thereafter.
- If Time Rotation was set to other than 24 hours, the rotation timer will start from the moment the setting is changed.
- When less output is needed, the additional Stages are turned off in the reverse order of how they were added. For instance, if the stages were added in the sequence A, B, and C, then they will be turned off in the sequence C, B, and finally A.

Note: If you do not set the system time, the BSC will assume it was installed at 2 PM.

LAST ON

- If Last-On is selected, the concept will follow this example; if A is the lead, the starting sequence of the boilers will be A, B, then C. When the de-energizing of the stages starts, it will turn off A, B, Then C. Then, stage D will be the new lead for the next load.

PURGE DELAY

Adjustable from 0.0 to 10.0 minutes

Default: 1.0

SELECT: MENU/System Settings/Purge Delay

(Not Available in Process)

- Most fully modulating units must go through a purge cycle before they are brought on line and can begin generating heat.
- When activating a new Stage, the BSC will hold its modulation at the Ignition % until the Purge Delay is over. This allows the unit to fully come on line and to begin producing output. Once the Purge Delay is over, the BSC can begin adjusting its modulation.
- The Purge Delay helps prevent short cycling of a newly activated Stage. Once a Stage is activated, it **MUST** run through the entire Purge Delay period.
- The minimum Purge Delay setting **MUST** be set according the unit's manufacturer specification.

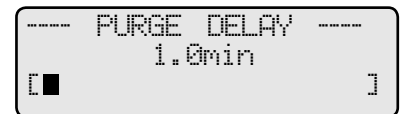

LAG DELAY

Adjustable from 0 to 60 minutes

Default: 0.0min

SELECT: MENU/System Settings/Lag Delay

(Not Available in Process)

- Set the Lag Delay to 0 min when two or more Stages will generally be needed to hold the load.
- The Lag Delay requires the previous stage to remain at 100% modulation for the full Lag Delay period before another stage can be activated. For example, if the Lag Delay was set to 10 minutes, the Lead Stage would need to remain at 100% modulation for a full ten minutes (never backing down to even 99%) before the lag stage could be activated.
- The Lag Delay is useful in installations where one unit should usually have enough output to hold the load unless it fails or load conditions become extreme.
- If the Lag Delay was set to other than 0, it will override the function of the Modulation Start % selected for each stage. That is, regardless of Modulation Start % setting, the lead stage must reach 100% and stay there before the lag Stage can be activated.
- The full Lag Delay must always elapse regardless of what happens to the system temperature/pressure. Therefore, set the Lag Delay to 0 min if you want smooth set point control of multiple units.

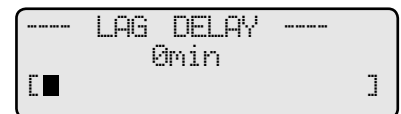

STANDBY TIME

Adjustable from 0 to 60 minutes

Default: 10 minutes

SELECT: MENU/System Settings/Standby Time

(Not Available in Process)

- The Standby Time only applies to Stages in Standby Mode. See page 24.
- A Standby Stage can only be activated after all the Stages in Auto Mode have run at 100% modulation for the full Standby Time.
- Standby Stages are used for backup or extreme load conditions. A Standby Stage can never be a Lead Stage
- The full Standby Time must always elapse regardless of what happens to the system temperature/pressure. Therefore, shorter Standby Times will result in smoother set point operation in extreme conditions. Longer Standby times may prevent a Standby boiler from starting if the other boilers can eventually meet the load or if the load decreases.

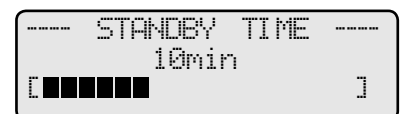

SYSTEM RUN-ON

Adjustable from 0 to 360 minutes

Default: 0 minutes

SELECT: MENU/System Settings/Standby Time

- The System output relay will energize whenever there is a call for output and the Shutdown feature is not active.
- The System will remain energized while any Stage is active. When the last Stage relay turns off, the System output will remain energized for the period of time set by the System Run-On.
- If the System Run-On is set to 0, the System output will turn off immediately when the last Stage turns off.
- A common use of the System output is to control a system pump in a heating system. After the last Stage is turned off, it is often desirable to run the system pump for an additional period of time to transfer the residual heat from the boilers to the building.
- When Outdoor Cutoff is used, the System output relay will remain energized whenever the outdoor temperature is below the Outdoor Cutoff. However, when the outdoor temperature rises 2°F above the Outdoor Cutoff, the System relay will remain energized for the Run-On period before turning off.

```

----- SYSTEM RUN-ON -----
              0min
[■]
    
```

SETBACK

Adjustable from 0F°/0C° to 75F°/24C°

Default: 0F°/0C°

SELECT: MENU/System Settings/More Settings/Standby Time

(Not Available in Reset Modes or EMS Modes)

- The Setback feature can be used to provide the BSC with a lower temperature/pressure Set Point when less load is required.
- The lower Set Point will appear on the main display indicating this condition.
- A typical use for Setback is to provide less system temperature/pressure to a factory or building during the night or on the weekends when product is not being manufactured or tenants are asleep or out, but heat is still required.
- The Setback will not be activated unless a signal is wired into the BSC EMS terminals. See Wiring the Setback on page 8.
- In Heating mode, the amount of Setback selected is subtracted from the Set Point when a Setback signal is received.
- For a temperature example, if the Set Point is 180°F and the Setback is 20°F, then when the EMS (+) and SIGNAL terminals are closed, the BSC will hold a Set Point of 160°F.

```

----- SETBACK -----
              0°F
[■]
    
```

ROTATE TIME

Adjustable from 1 to 999 hours

Default: 24 hours

SELECT: MENU/System Settings/More Settings/Lag Delay

- The Rotate Time only takes effect if the Auto Rotate type is Time. See Lead Auto Rotate on page 19.
- The default value is 24 hours and is appropriate for most systems. Using 24 hour rotation, at 2 am every morning the Lead Stage will be the next stage in Auto Mode.
- If the Rotate Time is not 24, the Lead Stage will change to the next stage in Auto Mode every time the Rotate Time has elapsed. For example, with a 12 hour Rotate Time, the Lead Stage will rotate from A to B after the first 12 hours of operation, and then from B to C after the next 12 hours, and so on.

```

-AUTO ROTATE PERIOD-
              0.0 hr
[■]
    
```

LAST-STAGE-HOLD

Adjustable from 0F°/0C° to 30F°/17C°

Default: 0F°/0C°

SELECT: MENU/System Settings/More Settings/Last-Stage-Hold

(Not Available in Process)

- The Last-Stage-Hold prevents short cycling of the Lead Stage during low load conditions where the system might have a load that is significantly less than the minimum output of one stage. When the BSC brings on the Lead Stage, the Set Point is quickly exceeded, and the Lead Stage is turned off. To prolong the run time during this type of condition, use the Last-Stage-Hold setting.
- The BSC will allow the system to exceed the Set Point by the Last-Stage-Hold value selected, before the Lead Stage is turned off.
- For example, with a Set Point of 160°F and a Last-Stage-Hold setting of 10°F, the Lead Stage will remain on until the Set Point reaches 170°F. During that period, the display will show "Hold Until 170F" then, the lead stage will turn off

```

- LAST STAGE HOLD -
              0°F
[■]
    
```

BSC Installation and Operation Manual

AVOID CONFLICTING BOILER LIMITS

⚠ WARNING

The limits set on the boilers **MUST** be set considerably higher than the BSC's Set Point for the reasons detailed below:

- The BSC sensor is located in the common header some distance from the boilers.
- As the temperature enters the header and travels to the sensor location, energy is dissipated. Therefore, the temperature in the header will be lower than that registered by sensors in the boilers.
- In addition to the normal drop experienced between the boiler's temperature and that read by the BSC sensor, the Last-Stage-Hold setting must be accounted for. The boiler limit must be set above the Set Point **PLUS** the Last-Stage-Hold **PLUS** the normal temperature drop experienced in the piping.
- Using the previous example of a 10°F Last-Stage-Hold with a 160°F Set Point, the boilers' limits must be set enough over 170°F to prevent the boilers' internal limits from being reached.

SET POINT AND DEFAULT TABLE

SENSOR	SET POINT			SETBACK			LAST-STAGE-HOLD			THROTTLE			TRIM (Default=0)	
	MIN	MAX	DEFAULT	MIN	MAX	DEFAULT	MIN	MAX	DEFAULT	MIN	MAX	DEFAULT	MIN	MAX
°F	70	250	140	0	75	0	0	30	0	2	20	2	-5	+5
°C	21	121	60	0	42	0	0	17	0	1	11	1		
15 PSI	0	15	5	0	5	0	0	3	1.5	0.25	3	0.5	-1.0	+1.0
30 PSI	0	30	8	0	10	0	0	6	3	0.5	6	1	-1.0	+1.0
100 PSI	0	100	30	0	30	0	0	20	10	1	20	2	-5	+5
200 PSI	0	200	60	0	60	0	0	40	20	2	40	4	-5	+5
300 PSI	0	300	80	0	90	0	0	60	30	3	60	6	-5	+5

SECURITY

ENABLE THE PASSWORD

Yes, No

Default: No

SELECT: MENU/System Settings/More Settings/Password

- The Password is to prevent unauthorized users from making changes to the BSC.
- Setting up the Password is not recommended as it slows down access, makes servicing more difficult, and can disable the system if management or ownership should change.
- The Password feature is not active unless a user enables it.
- If you choose to enable the Password, **DO NOT** forget the Password. Write it down and store it in a safe location known to at least one other authorized user.
- When the Password is enabled, none of the settings can be changed without entering the Password.
- Once the Password is entered, you can make multiple changes. The Password will expire 5 minutes after the last change has been made.
- The BSC has a built in default Password - MMOD.
- At the Login screen, you will have to enter the Password. Turn the *ADJUST/SELECT* knob until the desired letter is shown. Then, press the *ADJUST/SELECT* button to move on to the next letter.
- Enter *MMOD* into the Login screen.
- When completed, select *No* to the prompt *Change Password?*

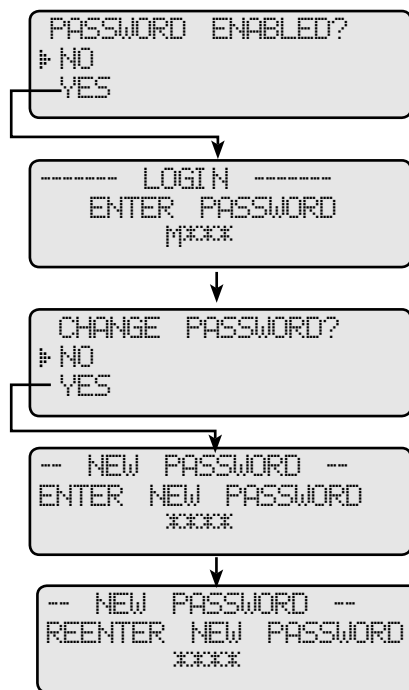

CHANGE THE PASSWORD

Yes, No

Default: No

SELECT: MENU/System Settings/More Settings/Password/Change Password?

- Follow the instructions to use the default Password, but select *Yes* to the prompt *Change Password?*
- Enter your new Password in the *New Password* screen. Turn the *ADJUST/SELECT* knob until the desired letter is shown. Then press the *ADJUST/SELECT* button to move on to the next letter. The password must consist of 4 letters.
- Reenter the same new password when prompted.
- If the password is entered correctly, the Success screen will appear. If you made a mistake, the whole procedure must be repeated.

SET THE TIME

SELECT: MENU/System Settings/More Settings/Set Time

- Setting the system time will set the default 24 hour rotation to occur at 2 am every morning.
- Turn the *ADJUST/SELECT* knob until the correct hour is shown. Be sure that *am* or *PM* is set correctly. Then select the hour.
- Turn the *ADJUST/SELECT* knob until the correct number of minutes is shown. Then select the minutes.

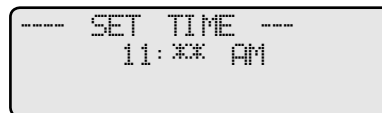

STAGE SETTINGS

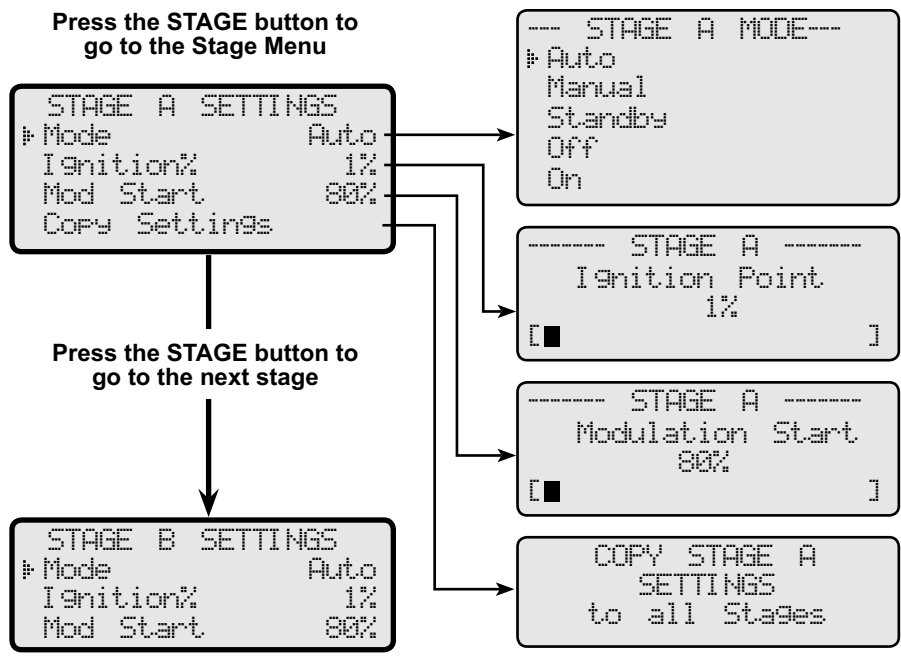

THE STAGE MENU

- In most installations, all Stage adjustments are the same, but each of the four output Stages can be configured differently if desired.
- If the stages are not set up properly, the BSC operation may appear to be erratic.
- From the main display, press the *STAGE* button. The *Stage A Settings* menu will be shown. Make all the appropriate settings for Stage A.
- After completing all the settings for Stage A, you have the option of copying these settings to the rest of the Stages. Everything but the Mode -- *Auto/Standby/Manual/Off/On* -- will be copied.
- Then press the *STAGE* button to bring up the *Stage B Settings* and make all the changes. Continue until all stages have been set.

```

STAGE A SETTINGS
┆ Mode           Auto
Ignition%       1%
Mod Start       80%
Copy Settings
    
```

MOVING AROUND THE STAGES MENUS

- Pressing the *STAGE* button allows you to automatically scroll through the *Stage A, B, C, and D Settings*.
- Pressing the *NEXT* button automatically moves you through the adjustments for each stage. For example, after viewing the *Ignition Point*, pressing the *NEXT* button will move you to the *Modulation Start*.
- Pressing the *NEXT* button does **NOT** save the setting. To save a new setting, you **MUST** press the *ADJUST/SELECT* knob.
- Pressing the *PREVIOUS* button automatically returns you to the previous adjustment for a Stage without having to return to the *Stage Settings* menu.

⚠ CAUTION

When in Stage menu, pressing the NEXT button DOES NOT save any configuration.

MODE

Auto, Standby, Manual, Off, On

Default: Auto

STAGE: STAGE MENU/Mode

- The BSC only controls the modulation of stages set to *Auto* or (after a delay) those set to *Standby*. None of the other settings are recommended for output Stages connected to active units. See *Display Stage Modulation Status* on page 12.
- Any stage without an active unit connected, and/or without an output relay must be set to *Off*.

```

--- STAGE A MODE---
┆ Auto
Manual
Standby
Off
On
    
```

The following list describes the *MODE* options:

- Auto** - The BSC will control the Stage's operation to maintain the Set Point. Only Stages set to *Auto* can be Lead Stages.
- Standby** - Standby Stages can only be activated when all Stages in *Auto* have been at 100% modulation for a selectable period of time. Standby is generally used when an older or less efficient unit is available, but is not desired except under extreme load conditions. A Standby Stage **Cannot** be a Lead Stage.
- Manual** - The Manual Mode should only be used when testing a Stage. Manual overrides the System Prove input. The exact percent of modulation for a Stage can be set with the Manual mode. Once selected, the unit will immediately turn on and be modulated to the selected percentage. The stage status will indicate **MAN** for the manually set stage.
- Off** - Any output Stage A through D without a relay, or not connected to a physical unit should be set to *Off*. The Off Mode can also be used to disable units, which are being serviced.
- On** - The On Mode should only be used when testing a stage. The On Mode overrides the System Prove input. Once selected as **On** the Stage will immediately turn on and be modulated to 100%.

IGNITION %

Adjustable from 1 to 100%

Default: 1%

STAGE: STAGE MENU/Ignition %

- The Ignition Point is the percent modulation that must be attained before the unit can be activated.
- For most modern power draft units, the Ignition Point should be set at 1%.
- Older units or atmospheric units may require the modulating fuel valve to be open from 20-50% before proper ignition can be attained. Check with the equipment manufacturer if you are in doubt about the minimum modulation signal required to activate the stage.

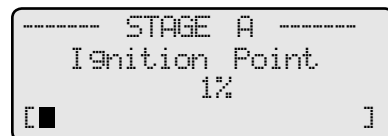

MODULATION START

Adjustable from 0 to 99%

Default: 80%

STAGE: STAGE MENU/Mod Start %

- The Modulation Start determines at what percent modulation of the previous stage the current stage in the sequence will be activated.
- For example, if the Modulation Start for Stage B is set to 75%, then when Stage A reaches 75% modulation, Stage B (if Stage B is in Auto Mode and is not already on) will be brought on.
- When modulation is decreasing, the lag unit will remain on in low modulation, until the previous stage reaches 40% of lag stage's Modulation Start point, or 2% above the Ignition Point, whichever is higher.
- Using the same example, as the load decreased, Stage B would modulate down to its Ignition %. Stage A would then modulate down to 30%. Only then, Stage B would turn off.
- If the Lag Delay is set to anything other than 0, a Stage must always go up to 100% modulation before the next stage is activated. However, the Modulation Start should still be set correctly, because it will be valid when modulation is decreasing.
- The Modulation Start point will generally be set differently based on the Modulating Mode selected.

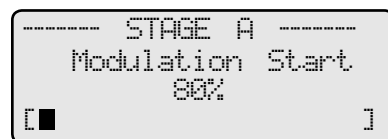

MODULATING MODE - NORMAL

(SEE STARTUP MODULATING MODE ON PAGE 16)

- Lower Modulation Start settings allow the next boiler in the sequence to be activated and warmed up, generally allowing more even set point control.
- Higher Modulation Start settings can prevent unnecessary stages from being activated.
- Some general guidelines to follow:
 - Less than 50% - not recommended in the Normal Modulating Mode.
 - 50%-70% - These lower settings might be used in an application that has wide load swings such as an industrial plant or a hospital. This allows an additional boiler to be brought on line before the previous boiler has begun to reach its capacity. The next boiler will now be available for fast, high demands.
 - 70-90% - This range is recommended for most applications. When there are several stages of relatively equal capacity and all can be used to hold the load, this allows some degree of overlap, without activating unnecessary stages.
 - 90-100% - Recommended when one stage can always handle the load while the other stages are mainly used for backup.

MODULATING MODE - PARALLEL

(SEE STARTUP MODULATING MODE ON PAGE 16)

- The Modulation Start should be set to the maximum value where the unit runs most efficiently.
- Contact the unit manufacturer to determine the appropriate setting.

COPY SETTINGS (STAGE A ONLY)

Stage (Button) *Stage Settings/Copy Settings*

- If all the stages set to Auto or Standby will have the same Ignition % and Modulation Start, then set it for Stage A and then copied to all other stages.
- It is still required to set the Mode for all other stages. The Mode setting WILL NOT be copied.

```
COPY STAGE A
SETTINGS
to all Stages
```

▲ ALERT

The Mode must be set for each stage. The *Copy Settings* command will not set the Mode for the rest of the stages.

MAINTENANCE

The Maintenance menu gives access to sensor and output trimming, Soft-Off, and Modulation Speed. If BSC had the communication package, then all the Network Settings will be listed under the Maintenance menu as well.

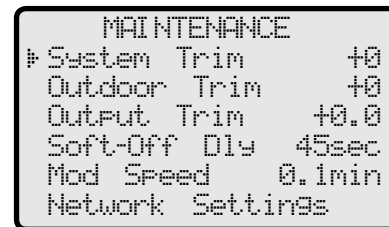

SYSTEM AND OUTDOOR TRIM

Adjustable from $-5F^{\circ}/-3C^{\circ}$ to $+5F^{\circ}/+3C^{\circ}$

Default: $0F^{\circ}/0C^{\circ}$

SELECT: MENU/<Maintenance>/System Trim

SELECT: MENU/<Maintenance>/Outdoor Trim

- The Weil McLain thermistor type sensors are very accurate, and normally require no calibration. Sometimes it may be desirable to make small adjustments to the displayed value for either the Outdoor temperature (OD) or the System temperature (SYS).
- For pressure transducers, the trim range will vary based on the Sensor Type Selected. See Set Point and Default Table on page 22.



STAGE OUTPUT TRIM

Adjustable from -1.0 to $+1.0$

Default: 0.0

SELECT: MENU/<Maintenance>/Output Trim

- The BSC gives the user the ability to adjust the percentage of Output for each stage individually to match the actual burner.
- Output Trim acts as an adjustment to a stage output percent to match the burner motor.
- When selecting Output Trim, Stage A Trim will show as the first option. By clicking on the Stage button, BSC will scroll through the rest of the stages.
- After adjusting the Output Trim, test the operation of the stage throughout the full range to make sure the results match your expectation.

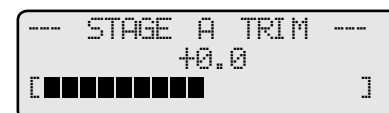

Click the Stage Button

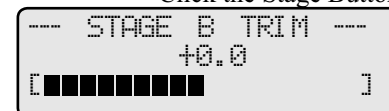

⚠ ALERT

DO NOT use the Output Trim for a Stage unless it is absolutely necessary. Test burner operation and modulation output matching after adjusting the Output Trim.

SOFT-OFF DELAY

Adjustable from 0 to 60 seconds

Default: 45 seconds

SELECT: MENU/<Maintenance>/Soft-Off Delay

- When a stage is no longer needed, the Soft-Off keeps that stage burner in Low Fire prior to turning it off.
- The display will show a percent that is equal to the Ignition % for the stage in Soft-Off delay. The Soft-Off will be indicated with the blinking Ignition % for that stage.
- If during the Soft-Off delay of a stage the BSC needs that stage to increase modulation, the stage will be released from the Soft-Off delay and resume normal operation.



MODULATION SPEED

Adjustable from 0.1 to 6.0 minutes

Default: 0.1 minutes

SELECT: MENU/<Maintenance>/Mod Speed

(Available in Process Mode Only)

- The Modulation Speed is designed to match the burner modulating motor speed to the BSC output. This allows BSC set to Process Operating Mode to respond accurately to system changes. See Operating Mode on page 16.
- When different stages have different modulating burner motor speeds, adjust the Modulation Speed to the longest motor speed.

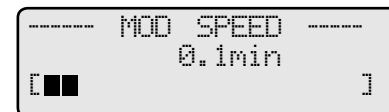

BACNET COMMUNICATION

- If the BSC was purchased with a communication package, some of the following settings must be configured to guarantee proper communication.

BACNET COMMUNICATION OPTION

SELECT: MENU/<Maintenance>/Network Settings

- After connecting the BSC to the BACnet network, see Wiring the BACnet Communication on page 10, the user must set the following parameters according the BACnet Network Administrator's instructions.



BACNET DEVICE ID

- This is a unique ID within the BACnet network. It must be provided by the BACnet Network Administrator and entered into the **BACnet ID** field.

IP ADDRESS

- The IP address must be unique within the single network the BSC resides on.
- The IP address must be provided by the Network Administrator.
- Enter the IP address in the **IP** field. After dialing each octet, press the **ADJUST/SELECT** button to accept.

MASK ADDRESS

- The Subnet Mask, in combination with the IP address, is used to identify the BSC in a TCP/IP network environment.
- The Subnet Mask must be provided by the Network Administrator.
- Enter the Subnet Mask in the **Msk** field. After dialing each octet, press the **ADJUST/SELECT** button to accept.

GATEWAY ADDRESS

- The Gateway is used to provide a mean for the BSC to communicate outside the local network environment.
- The Gateway must be provided by the Network Administrator.
- Enter the Gateway in the **Gw** field. After dialing each octet, press the **ADJUST/SELECT** button to accept.

▲ ALERT

A BSC that is BACnet capable will display -- NETWORK PANEL -- on the 2nd row of the display when it is in screen saver mode. See page 12.

BSC BACNET VARIABLE LIST

The following is the BACnet variable list that can be used to communicate with the BSC.

OBJ ID	OBJECT NAME	DESCRIPTION	TYPE*	UOM	RANGE / STATES	READ ONLY
0 through19	BTIME00 through BTIME19	Stage Run-Time	AV	Minutes(72)	0 - 2,147,483,647	X
100	CO	Outdoor Cutoff Temp	AV	°C(62), °F(64)	-6 - 38°C, 20 - 100°F	
200 through219	FIRE00 through FIRE19	Ignition Level	AV	%(98)	1 - 50	
300	GAIN	Modulation Gain	AV	none (95)	-10 - +10 (non process), - 10 (process temp), 0.25 - 20.0(process psi)	
400	HC	Heat/Cool	BV		0=heat, 1=cool	
500	HFHOLD	High Fire Hold	AV	Minutes(72)	0 - 60	
600	INMODE	Sensor Mode	MV		1=°F, 2=°C, 3=15psi, 4=30psi, 5=100psi, 6=200psi, 7=300psi, 8=HWR, 9=Reset °F, 10=Reset °C	X
700	LEAD	Lead Stage	MV		0 - 19 = A - T	
800	LFHOLD	Pre-purge Delay	AV	Minutes(72)	0 - 10	

BSC Installation and Operation Manual

OBJ ID	OBJECT NAME	DESCRIPTION	TYPE*	UOM	RANGE / STATES	READ ONLY
900 through 919	LOCK00 through LOCK19	Lockout Input	MV		1=(inactive), 2=Lockout,3=Comm Error	X
1000	LSTHOLD	Last-Stage-Hold	AV	Psi (56), °C(62), °F(64)	0 - 3.0psi, 0 - 30psi °C °F	
1100 through 1119	MAN00 through MAN19	Manual Modulation Level	AV	%(98)	0 - 100	
1200	MAXSTG	Maximum Stages	AV	none (95)	4 - 20	X
1300	MIN	Minimum Target	AV	°C(62), °F(64)	21 - 68°C, 70 - 180°F	
1400 through 1419	MODE00 through MODE19	Stage Mode	MV		1=Auto, 2=Standby, 3=Manual, 4=Off, 5=On	
1500 through 1519	MODST00 through MODST19	Modulation Start Point	AV	%(98)	0 - 99	
1600 through 1619	MTRIM00 through MTRIM19	Modulation Output Trim	AV	none (95)	-1.0 - +1.0	
1700	ODTEMP	Outdoor Sensor	AV	°C(62), °F(64)	-40 - +122°C, -40 - +250°F	X
1800	ODTRIM	Outdoor Sensor Trim	AV	°C(62), °F(64)	-5 - +5	
1900	OFF	Offset Temp	AV	°C(62), °F(64)	-28 - +28°C, -50 - +50°F	
2000	PDATE	Panel Date	AV	Days (70) since 1/1/1981	0 - 2,147,483,647	
2100	PTIME	Panel Time	AV	Minutes(72) since 0:00	0 - 1439	
2200	R	Reset Ratio	MV		1=1:4, 2=1:3, 3=1:2, 4=1:1.5, 5=1:1.25, 6=1:1, 7=1.25:1, 8=1.5:1, 9=2:1, 10=3:1, 11=4:1	
2300	RTMODE	Lead Stage Rotation Mode	MV		1=Manual, 2=Time, 3=Last-On	
2400	RTTIME	Periodic Rotation Interval	AV	Hours(71)	1 - 999	
2500	SB	Setback	AV	Psi (56), °C(62), °F(64)	0 - 7.5psi, 0 - 75psi °C °F	
2600	SETPT	Set point	AV	Psi (56), °C(62), °F(64)	0.0-15.0psi, 0.0-30.0psi, 0-100psi, -40 - +122°C, -40 - +250°F,	
2700	SRUNON	System Run-on	AV	Minutes(72)	0 - 60	
2800	STBYDLY	Standby Delay	AV	Minutes(72)	1 - 60	
2900 through 2919	STONOFF00 through STONOFF19	Stage Relay	BV		0=Off, 1=On	X
3000 through 3019	STPCT00 through STPCT19	Modulation Level	AV	%(98)	0 - 100	X
3100	SYSONOFF	System Relay	BV		0=Off, 1=On	X
3200	SYSEN	System Sensor	AV	Psi (56), °C(62), °F(64)	0.0 - 15.0psi, 0.0 - 30.0psi, 0 - 100psi, -40 - +122°C, -40 - +250°F,	X
3300	TARG	Calculated Target	AV	°C(62), °F(64)	21 - 122°C, 70 - 250°F	X

- * AV=analog value(2),
 BV=binary value(5),
 MV=multi-state value(19).

Note: The device object id is set through the menus. The device object name is 'WM_' followed by the panel serial number.

Note: All objects with multiple UOM's depend upon the value of INMODE to determine which to use. Objects with only °F/°C UOM's default to °F when INMODE is not temperature.

Note: OFF, R and TARG have no effect unless INMODE is set to Reset °F or Reset °C.

Note: When writing to MAN, MODE will change to Manual.

TROUBLESHOOTING

No Display, or Garbled Display

Check the 120VAC power input to the BSC. Turn power to the BSC off and back on. Make sure that the Ground screw is connected to a reliable Earth Ground. Make sure that all wiring is fed to the control through the bottom knockouts and that no high voltage wiring is running behind the control board.

SENSOR INPUTS

Display shows Sensor OPEN or SHORT

When the reading is **OPEN**, Check the sensor is connected and the wires are continuous to the BSC. Finally follow the procedure for Incorrect Temperature or Pressure Display. When the reading is **SHORT**, remove the wires from the sensor terminals. The display should change to read **OPEN**. If it does not, the BSC may be damaged.

Display shows an Incorrect Temperature

Remove the wires from the sensor terminals. The display should change to read **OPEN**. If it does not, the BSC may be damaged. Take an ohm reading across the detached sensor wires. The ohm reading should correspond to the Temperature sensor Table. If it does not, the sensor may be damaged.

Display shows an Incorrect Pressure

If the reading is a specified amount above or below the actual pressure adjust it using the System Trim. If the reading is **SHORT**, remove the wires from the sensor terminals. The display should change to read **OPEN**. If it does not, the BSC may be damaged.

CONTROL OPERATION

No Heat

- **Prove** - Even though, the system relay may be energized, the BSC will not energize any stage relays unless the Prove is shorted. Check Message Display Line on page 12.
- **Shutdown** - The BSC will activate stage outputs when the Shutdown terminals are short. Check Message Display Line on page 12.
- **Sensor Fault** - When the Sensor Fault is set to Shutdown in the startup menu on page 7, the System sensor fault (in all Sensor Type modes) or the Outdoor sensor fault (in Reset mode) will de-energize all stage relays. Check the display for sensor values.
- **System or Outdoor Sensor** - If the System or Outdoor sensor reading was higher than the actual temperature, the BSC might not bring any stage on. Check "Display shows an Incorrect Temperature" section.

Too Much Heat

Check if the control has any of the following:

- **Reset Ratio and Offset** - If excessive heat occurs only in certain weather conditions, adjust the Reset Ratio and Offset (See Understanding Operating Concept on page 5). If excessive heat occurs year round, reduce the Offset.
- **Boiler Mode Settings** - The BSC will only modulate boilers their mode is set to Auto or Standby. Check to if any boiler stage is set to Manual or On. See Mode on page 24.
- **Control Settings** - The Last-Stage-Hold will allow only the Lead boiler to stay on for an additional number of degrees. If the setting is too high, and only the Lead boiler is on, the system can over heat. Reduce the Last-Stage-Hold setting. See page 21.

Temperature Sensor Chart

TEMPERATURE (in Degrees °F)	Value (in Ohms)
-30	117720
-20	82823
-10	59076
0	42683
10	31215
20	23089
25	19939
30	17264
35	14985
40	13040
45	11374
50	9944
55	8714
60	7653
70	5941
80	4649
90	3667
100	2914
110	2332
120	1879
130	1524
140	1243
150	1021
160	842
170	699
180	583
190	489
200	412
210	349
220	297
230	253
240	217
250	187

Too Little Heat

Check if the control has any of the following:

- **Reset Ratio and Offset** - If reduced heat occurs only in certain weather conditions, adjust the Reset Ratio and Offset (See Understanding Operating Concept on page 5). If reduced heat occurs year round, increase the Offset.
- **Setback** - If reduced heat occurs only during specific hours, check the Setback value and the source of the setback signal. Either reduce the Setback setting (See page 21) or change the hours the setback signal is activated.

BSC SPECIFICATIONS

Voltage Input:	120 VAC 60 Hz
Power Consumption:	30 VA Max
Operating Temperature:	20°F/-7°C to 120°F/49°C
Operating Humidity:	20% to 80%
Dimensions:	13"W x 13" H x 5 1/2" D
Weight:	14 pounds
Lead Stage Rotation:	Time (1 to 999 Hours (41 days)), Manual, <i>Last-On</i>
System Output Relay:	(1) N.O. S.P.S.T
Stage Output Relay:	(4) N.O. S.P.S.T
Stage Modes:	Auto, Manual (0% - 100%), Standby, On, Off
Standby Time:	1 to 60 minutes
Modulating Output Types:	Total of four outputs. Can be Current (4-20mA)/Voltage (0-5V, 0-10V, 1-5V, 2-10V)/135Ω
Output Relay Ratings:	(5) 1 Amp Pilot Duty, 6Amp resistive at 120 VAC 60 Hz (1/3HP), 15A total for all circuits
Add-On Extension Panels:	up to two Extension Panels using RS485, Each Panel with 8 modulating stages
Ignition Point %:	1 to 50%
Modulation Start Point %:	0 to 100%
Modulation Modes:	Normal or Parallel
Heat/Cool Modes:	Heating or Cooling
Temperature Display:	Fahrenheit or Celsius.
Display:	Alphanumeric (4 rows x 20 char. each)
LED:	(1) System Output relay, (4) Boiler Output relays
Sensor Ranges:	Outdoor temperature sensor -35°F/-37°C to 250°F/121°C Heating system sensor -35°F/-37°C to 250°F/121°C
Outdoor Cutoff Range:	20°F/-7°C to 100°F/38°C, ON and OFF
Reset Ratio Range:	(1.00 : 4.00) to (4.00 : 1.00) (Outdoor : System Water)
Offset Adjustment:	-40F°/-22C° to + 40F°/+22C
Minimum Water Temperature (Reset Only):	70°F/21°C to 170°F/77°C
Set Point Temperature Range:	70°F/21°C to 250°F/121°C
EMS Temperature Range:	70°F/21°C to 240°F/116°C
System Run-On:	0 to 360 minutes
Purge Delay:	0.0 to 10.0 minutes
Lag Delay:	0 to 60 minutes
Last-Stage-Hold:	Temperature 0F°/0C° to 30F°/17C° Pressure (0-15psi or (0-30psi) 0 to 3 psi Pressure (0-100psi, (0-200psi), or (0-200psi) 0 to 10% of full range
Setback:	Temperature 0F°/0C° to 75F°/42C° Pressure (0-15 or 0-30) 0-7.5 psi Pressure (0-100) 0-75psi Pressure (0-200) 0-150psi Pressure (0-300) 0-200psi
Power Backup:	Lithium coin battery, 100 days minimum 5 year replacement (Maintains Clock in power outages).
External Inputs:	Shutdown Input, Setback Input, and Prove Input (Dry-contacts Only) External Set Point input (4-20mA)
Remote Communication Option:	BACnet IP (Optional)